

**GeniSys™**  
**Controller**  
Version 1.08

Copyright © 2016 Allen Organ Company LLC  
All Rights Reserved

# GENISYS™ CONTROLLER GUIDE

<b>A.</b>	<b>BASIC OPERATION .....</b>	<b>2</b>
1.	Start-Up Sequence .....	2
2.	Advancing Through the Windows .....	3
3.	Selecting the Capture Memories .....	3
4.	Saving Registrations Using the Pistons/Toe Studs .....	4
5.	Locking Capture Memories .....	4
6.	Unlocking Memories Using Your Code .....	5
7.	Unlocking All Memories If You Forget Your Code .....	5
8.	Stop Action and Capture Self Check .....	6
9.	Stoplist Library™ .....	6
10.	Acoustic Portrait™ Settings .....	7
<b>B.</b>	<b>USB OPERATION .....</b>	<b>10</b>
1.	USB Memory Port .....	10
2.	GeniSys™ Sequencer .....	11
3.	Capture Memory Registration Save/Load .....	18
4.	Hymn Player ( <i>Classic models only</i> ) .....	23
5.	Prelude Player .....	24
<b>C.</b>	<b>ADVANCED OPERATION .....</b>	<b>25</b>
1.	Selecting an Alternate Tuning .....	25
2.	Configuring General Pistons .....	26
3.	Restoring Original Factory Settings .....	27
4.	Global Tuning .....	28
5.	Headphone Volume ( <i>REN-25 based instruments and only if the Headphone feature is enabled</i> ) .....	28
6.	Sostenuto ( <i>optional</i> ) .....	29
7.	Piston Sequencer ( <i>optional</i> ) .....	30
<b>D.</b>	<b>MIDI FUNCTIONS .....</b>	<b>41</b>
1.	Standard MIDI Channel Assignments .....	41
2.	Selecting Program Change Modes .....	41
3.	General MIDI Sound Names or Program Numbers .....	43
4.	Assigning MIDI Program Changes to Organ Pistons .....	45
5.	MIDI Bank Selecting .....	46
6.	Changing the MIDI Base Channel .....	48
7.	MIDI Expression Settings .....	49
8.	MIDI Sustain Kick Switch ( <i>optional</i> ) .....	50
9.	Organ Local Off .....	50
10.	Transmission/Reception of Individual Stop Data .....	51
<b>E.</b>	<b>MIDI GUIDE .....</b>	<b>52</b>
1.	MIDI for Organists .....	52
2.	Allen's Exclusive MIDI System .....	53
3.	MIDI Transmission Channels .....	54
4.	GENERAL MIDI SOUND SET .....	55
<b>APPENDIX A:</b>	<b>MIDI IMPLEMENTATION CHART .....</b>	<b>56</b>
<b>APPENDIX B:</b>	<b>GNU PUBLIC LICENSE INFORMATION .....</b>	<b>57</b>

## INTRODUCTION

The GeniSys™ Controller is an interface that controls many organ functions and a variety of MIDI functions. The GeniSys™ Controller includes a LCD (liquid crystal display) window that displays functions, one at a time, as well as an integrated CHANGE control knob with push buttons used to make selections. Each window function is described in detail.

### A. BASIC OPERATION

#### 1. Start-Up Sequence

Turn on the organ's main power switch. During the start-up sequence, the LCD window will display:

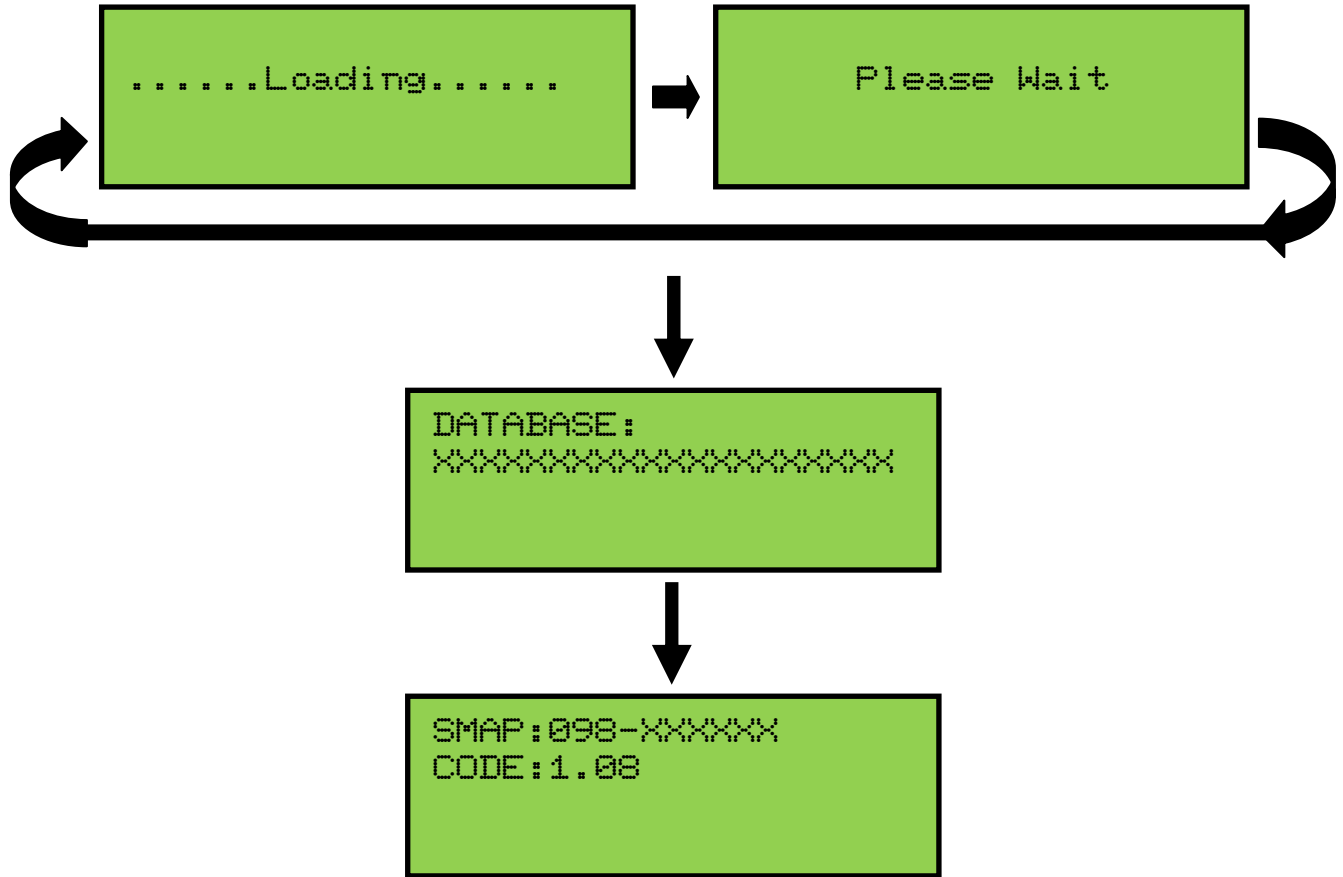

Once the GeniSys™ computer has completed its initial start-up procedure, the LCD will display the current stopmap level (SMAP) and operating software base code level (CODE) currently installed in the organ.

Then, the *Main Window* function is displayed:

```
MEMORY-_ 1 XPOSR 8
PISTON=
PISTON SEQUENCR=OFF
```

**Important:** The Allen Organ includes several self-testing features. If a warning is displayed within this sequence, please contact your Allen authorized representative immediately!

## 2. Advancing Through the Windows

The Allen Organ GeniSys™ operating software contains many settings that are user-programmable. Each programmable setting can be adjusted via the GeniSys™ Controller. These programmable settings are divided up into many window functions. To advance the GeniSys™ Controller's display to the next window function, locate and press the **MOVE** button until the cursor is positioned under the letter **M**, within the word **MEMORY** in the display. Once the cursor is positioned, slowly turn the **CHANGE** control knob clockwise. The display will advance to the next window function. When the second window function is displayed, turn the **CHANGE** control knob counter-clockwise, the display will return to the *Main Window* display function. Turn the **CHANGE** control knob counter-clockwise again and the last window function will display. The window functions “wrap around” for ease of accessing functions quickly.



or

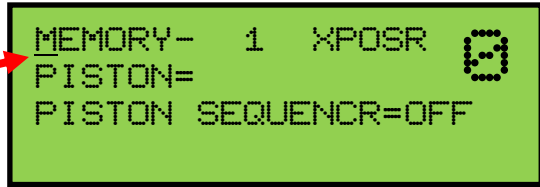

```
MEMORY- 1 XPOSR   
PISTON=  
PISTON SEQUENCR=OFF
```

**Remember:** You may return to the *Main Window* function at any time by pressing and holding the **SET** piston. Then, while holding **SET**, press the **CANCEL** piston, release both pistons. This procedure will always return the GeniSys™ Controller's display to the *Main Window* function.

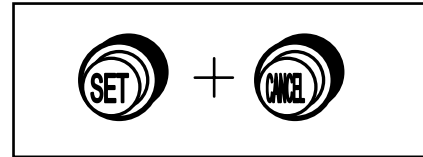

For reference, the last window function is:



```
UNLOCK ALL  
CAPTURE MEMORIES
```

## 3. Selecting the Capture Memories

Locate the **MOVE** button on the GeniSys™ Controller. Press this button to position the cursor to the left of the memory number on the display. Once the cursor is positioned, turn the **CHANGE** control knob clockwise to select the memories sequentially from 1 to 2 to 3, etc. Or, turn the **CHANGE** control knob counter-clockwise to select the memories sequentially from 1 to 40 to 39 to 38...

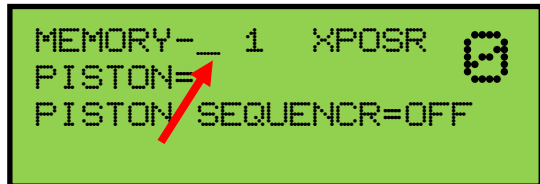

```
MEMORY- 1 XPOSR   
PISTON=  
PISTON SEQUENCR=OFF
```

The capture memories allow you to save different registrations on each piston/toe piston. This means General Piston 1 on Memory 1 can be totally different from General Piston 1 on Memory 2, 3, 4, etc.

#### 4. Saving Registrations Using the Pistons/Toe Studs

A **registration** is any combination of stops. These registrations can be stored (remembered) by the organ's capture memory system. The pistons provide a way to make changes quickly from one registration to another.

**General Pistons** are those that affect all stops on the organ. General pistons are usually located on the left side, underneath the keyboards on the piston rails.

**Divisional Pistons** affect only those stops associated with the particular manual/division. Divisional pistons are usually located in the center of the piston rails below the keyboards.

Most model organs contain **Toe Studs**. Toe Studs are located just above the pedalboard. Numbered Toe Studs to the left of the expression shoes usually duplicate General Pistons, while those to the right of the expression shoes are usually for the Pedal Division.

##### To Save a Registration to a General Piston:

The *Main Window* function in the GeniSys™ Controller must be displayed (See Section A-2). Select any memory number (1, 2 ... 38, 39, 40, etc.)(see section A-3); however, for this example use Memory 1. Next, select the stops you want General Piston 1 to remember. Once the stops are selected, press and hold the **SET** piston, then press and release General Piston 1. Finally, release the **SET** piston. General Piston 1 will now store the selected stops in memory.

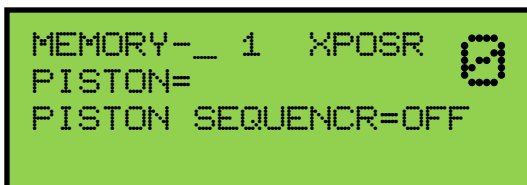

```
MEMORY-_ 1 XPOSR [9]
PISTON=
PISTON SEQUENCER=OFF
```

**Note:** *General Pistons are often set gradually from soft to loud with General #1 the softest and General #10 the loudest.*

##### To Save a Registration to a Divisional Piston:

The *Main Window* function in the GeniSys™ Controller must be displayed (See Section A-2). Select any memory number (1, 2 ... 38, 39, 40, etc.)(see section A-3); however, for this example use Memory 1. Next, select any Swell division stops you want Swell Piston 1 to remember. Once the stops are selected, press and hold the **SET** piston, then press and release Swell Piston #1. Finally, release the **SET** piston. Swell Piston #1 will now store the selected Swell division stops in memory.

#### 5. Locking Capture Memories

All memories, except Memory 1, may be locked or unlocked individually to prevent unintentional or unauthorized changes to that memory's contents.

**Note:** Memory 1 remains unlocked as a convenience to visiting or substitute organists (*if applicable*).

The GeniSys™ Controller must display the *Main Window* function (See Section A-2). Select a capture memory to lock. After registrations are stored to pistons, (See Section A-4) choose three digits you can easily remember (e.g., 1-2-3, 2-1-5, etc.). General Piston numbers reflect their respective digits listed on the piston (Piston 10 = zero).

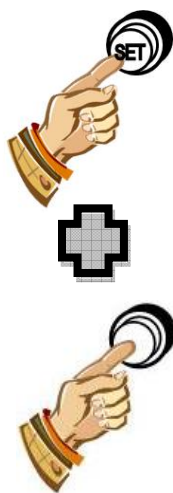

On the GeniSys™ Controller, locate the **ACT** button. Press and hold the **ACT** button. Then, while holding **ACT**, press the General Pistons that will correspond to your three-digit code. Release the **ACT** button and an "L" will appear next to the "M" number in the display, indicating this memory is now locked. As long as the memory remains locked, the piston registrations on that

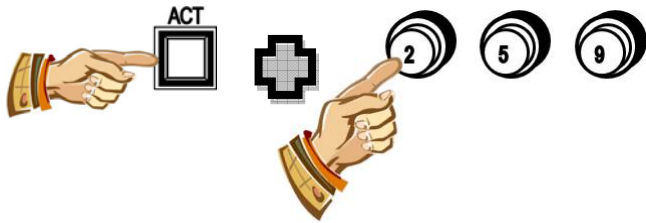
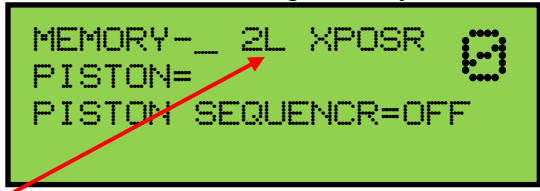

memory cannot be changed. Other organists will still be able to use the locked registrations; however they cannot be changed.



Remember; choose an easy to remember three-digit code.

**Note:** Each capture memory level lock code can be different!

### 6. Unlocking Memories Using Your Code

The *Main Window* function must be displayed (See Section A-2). To unlock a memory, select the capture memory to be unlocked. Remember, locked capture memories will have an "L" behind the memory number. Once a capture memory is selected, press and hold the **ACT** button within the GeniSys™ Controller. Then, while pressing **ACT**, enter the same three-digit code that was used to

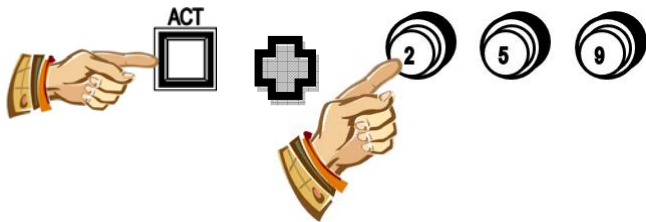
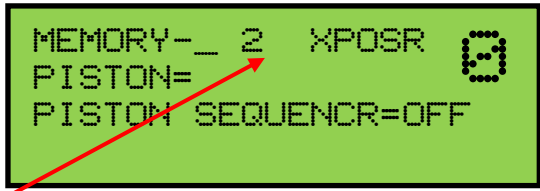

lock this memory (See Section A-5). Release the **ACT** button. If the correct code is entered, the "L" will disappear, indicating the selected memory is now unlocked.

### 7. Unlocking All Memories If You Forget Your Code

Advance to the 'UNLOCK ALL CAPTURE MEMORIES' window function (see section A-2).

Press and hold the **ACT** button within the GeniSys™ Controller. Then, while holding **ACT**, press General Pistons 2-5-5, in sequence. Release the **ACT** button. All capture memories are now unlocked, including those memories other organists may have locked, however, programmed registrations will remain unchanged. The display will automatically return to the *Main Window* function.

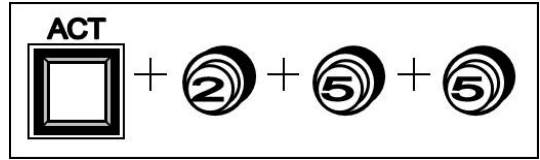

## 8. Stop Action and Capture Self Check

This feature self-checks the capture system. The test insures each stop is functioning properly and is controllable by the capture system.

Advance to the 'SELF CHECK' window function (*see Section A-2*).



To start the self-check, press the **MOVE** button to position the cursor on the word "OFF". Turn the **CHANGE** control knob to start the Self Check function. The display will indicate the Self Check function is now "ON". The stops will turn on and off consecutively one at a time. *If any stop position does not light (or move, if mechanical drawknobs), please notify your certified Allen service technician.*



```
SELF CHECK
  OFF
```



```
SELF CHECK
  ON
```

During the testing process you can stop the Self Check function at any time by turning the **CHANGE** control knob until "OFF" appears within the display or by using the **SET** and **CANCEL** pistons to also return to the *Main Window* function (*see Section A-2*).

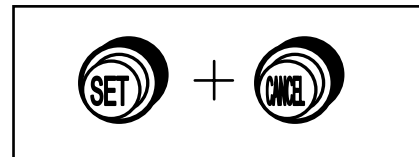

## 9. Stoplister Library™

Most organs are equipped with four (4) complete voicing suites as standard and can be updated to include up to nine (9) complete voicing suites (*see model specific specification documents as to the available standard/optional voicing suites*). A new voicing specification can be selected within the GeniSys™ Controller at any time. To change a voicing specification, advance to the 'STOPLISTER LIBRARY™' window function (*see Section A-2*). The display will indicate the current voicing specification loaded.



```
SOUND LIBRARY
  CLASSIC ALLEN
Press SET + [ACT]
```

To change to a different voicing specification, press the **MOVE** button to position the cursor on the voicing specification name. Turn the **CHANGE** control knob to select a different voicing specification.

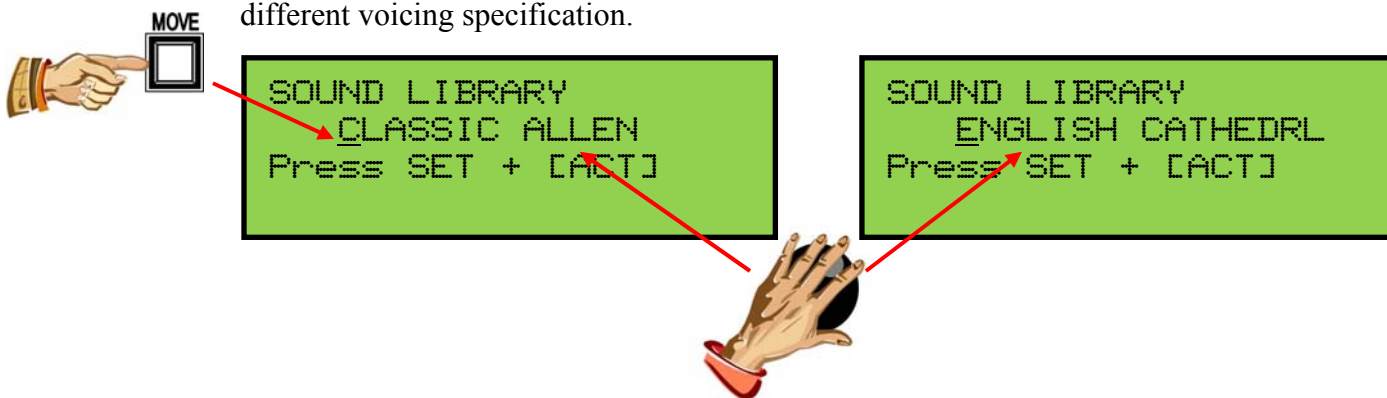

When a new voicing specification is displayed, press and hold the **SET** piston. Then, while holding **SET**, press the **ACT** button. Release both.

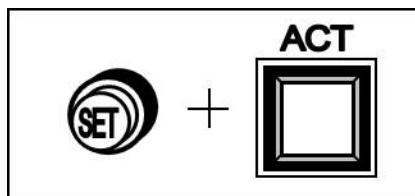

The display will indicate the selected voicing specification is loading. Once the new voicing specification has loaded, the capture system will automatically cancel all stops and return to the Sound Library selection display indicating the organ is now ready to play.

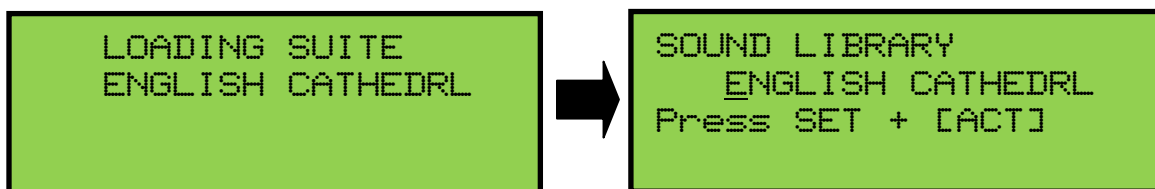

To return to the *Main Window* function, press and hold the **SET** piston, then press the **CANCEL** piston. Release both.

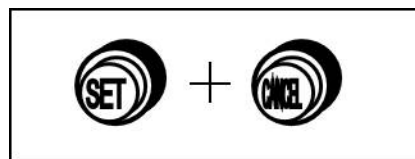

**Important:** The organ will not be able to be played while a new voicing specification is loading.

## 10. Acoustic Portrait™ Settings

There are 10 available Acoustic Portrait™ pallets to select from. The rocker switch labeled ACOUSTICS within the GeniSys™ Controller must be switched ON to hear the Acoustic Portrait™ selection. The Acoustic Portrait™ gain (volume) may be adjusted. The gain is displayed in dB (decibels). The Acoustic Portrait™ gain range is adjustable from +6dB to minus 35dB. Minus 35dB is the least amount of gain while +6dB is the most amount of gain available.

ACOUSTICS

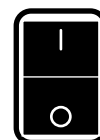



To change the active Acoustic Portrait™ or adjust the Acoustic Portrait™ gain, advance to the “ACOUSTIC PORTRAIT” window function (*see Section A-2*). The window will display the name of the currently selected Acoustic Portrait™ pallet on line 2 with the Gain setting on line 3.

```
ACOUSTIC PORTRAIT
  Large Room 1
  Gain = -6 dB
```

To change the Acoustic Portrait pallet, press the **MOVE** button to position the cursor on the Acoustic Portrait pallet name. Turn the **CHANGE** control knob to select a different Acoustic Portrait pallet name.

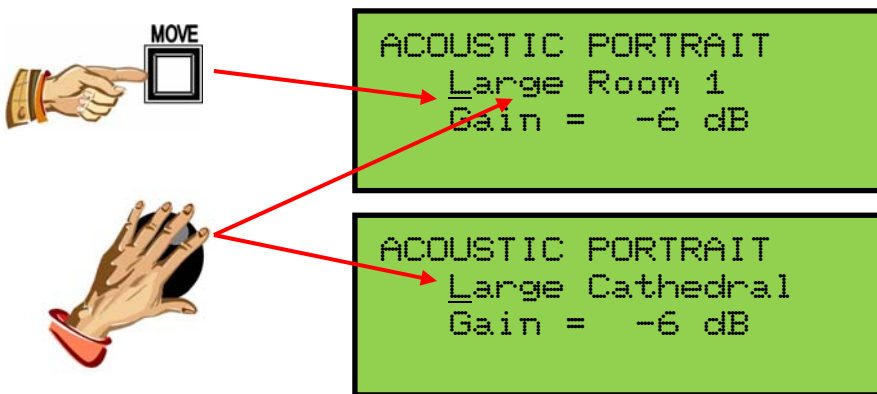

**Note:** The selection change will not be immediate. The newly selected Acoustic Portrait pallet will begin loading in approximately 3 seconds. The display will indicate the newly selected pallet is loading and when it has completed:

```
ACOUSTIC PORTRAIT
  Loading Portrait
  Gain = -6 dB
```



```
ACOUSTIC PORTRAIT
  Large Cathedral
  Gain = -6 dB
```

### Acoustic Portrait Gain (Volume) Adjustment:

To change the Acoustic Portrait Gain setting, press the **MOVE** button to position the cursor on the Acoustic Portrait gain setting. Turn the **CHANGE** control knob to change the gain setting. Gain adjustment range is from minus 35dB to +6dB. Minus 35dB is the least amount of gain while +6dB is the most or maximum amount of gain.

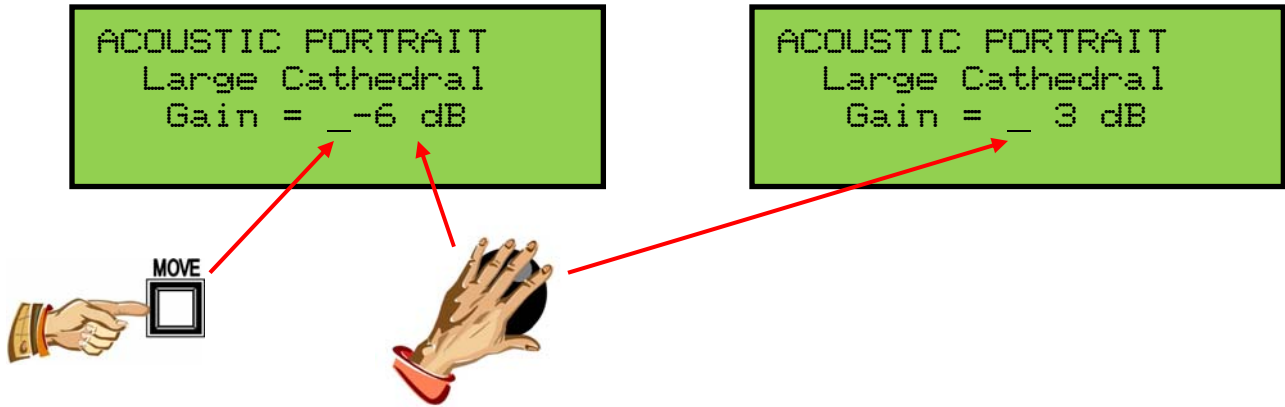

### Acoustic Portrait™: Available Reverb Pallets

1. Pipe Chamber
2. Small Theatre
3. Small Church
4. Medium Room 1
5. Medium Room 2
6. Medium Room 3
7. Large Room 1
8. Large Room 2
9. Cathedral
10. Large Cathedral

## B. USB OPERATION

### 1. USB Memory Port

GeniSys™ consoles are equipped with a USB type memory port. Depending on the model instrument, the USB memory port can be located at various positions on the console. The USB memory port can accept USB flash devices up to 32GB in size.



**Important!** USB flash devices larger than 32GB will not operate correctly within GeniSys™ model instruments. Data loss may occur if flash devices larger than 32GB are used.



The USB flash device is used for saving or backing up the instrument's capture memories and for the built-in Sequencer. These functions will not operate unless a USB flash device has been inserted into the USB memory port. However, the USB flash device does not need to be installed for normal playing operation of the instrument.

#### Insert a USB Flash Device

Locate the USB memory port on the instrument and carefully insert the USB flash device into the port socket. The USB flash device can only be inserted in one orientation, so do not force the USB flash device into the socket if it doesn't fit correctly. Doing so may damage the port socket and the USB flash device. If the USB flash device doesn't fit correctly, re-orient the USB flash device and re-insert it into the port socket. Once the USB flash device is seated correctly into the port socket, the instrument will automatically connect to the USB flash device. This will take a few seconds.

#### Remove a USB Flash Device



**Important!** Never remove a USB flash device from the USB memory port without first operating the SAFELY REMOVE USB function from within the GeniSys™ Controller. Removing the USB flash device without operating this function may cause data loss to occur on the USB flash device.

To remove a USB flash device, advance to the "SAFELY REMOVE USB" window function (*see Section A-2*).

To remove the USB flash device, press the **ACT** button. The display will return to the *Main Window* function when it is safe to remove the USB flash device from the USB memory port socket.

**Note:** If a USB flash device is not connected to the instrument's USB memory port, the SAFELY REMOVE USB function will not appear within the GeniSys™ Controller.



```
_Safely Remove USB?  
Press [ACT] button.
```

```
MEMORY-_ 1 XPOSR  
PISTON=  
PISTON SEQUENCER=OFF
```

## 2. GeniSys™ Sequencer

GeniSys™ instruments contain the added versatility of a built-in console sequencer. Similar to the operation of an external MIDI sequencer, the GeniSys™ Sequencer will record and playback an organist's performance in exacting detail. Every key, pedal, piston, stop and expression movement is recorded and played back as it was originally recorded by the organist. Performances can then be saved and loaded for playback at a later time using a USB flash device.



**Important!** A USB flash device must be connected to the instrument's USB memory port in order to access the Sequencer function within the GeniSys™ Controller.

The GeniSys™ Sequencer is limited to a single-pass recording. Performance data is saved as a Type 1 MIDI file (multiple MIDI tracks) in standard MIDI file format. The MIDI file may be edited when the USB flash device is inserted into a standard PC computer and more advanced MIDI sequence editing software is used. The GeniSys™ Sequencer will playback both Type 0 and Type 1 MIDI files in standard MIDI file format.

To access the GeniSys™ Sequencer, advance to the Sequencer window function (*see section A2*).

The GeniSys™ Sequencer contains many display functions. Here is a quick breakdown of those functions and what they do:

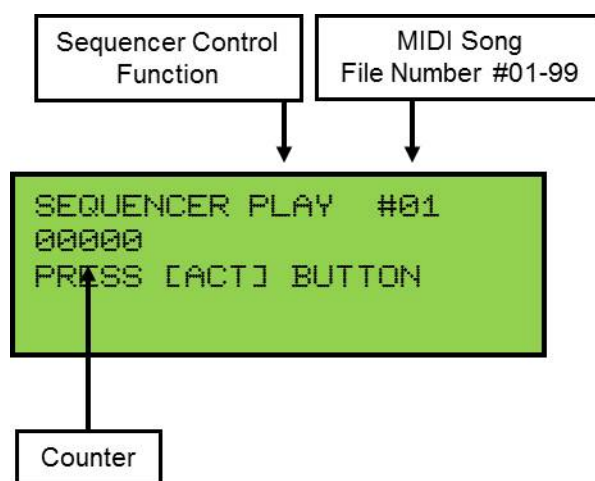

### Sequencer Control Function:

- PLAY: Standard Sequencer File Playback; PLAY mode will play the selected MIDI song file number.
- PLAY+: "Playlist" Sequencer File Playback; PLAY+ mode will play all recorded MIDI song file numbers in order from lowest to highest.
- REC: Record Sequencer File; REC mode will record a performance and save the recorded performance data into the selected MIDI song file number.
- DEL: Delete Sequencer File; DEL mode will delete the displayed MIDI song file number.

### MIDI Song File Number:

MIDI song files use a specific filename format; SONGXX.mid, where “XX” is the file number. Any file number between 01 and 99 may be selected. MIDI song files which do not use the specified filename format will not be recognized by the Sequencer and therefore cannot be loaded for playback.

### MIDI Song File Storage:

MIDI song files are stored within the [WORK] directory on the USB flash device. MIDI song files recorded by the Sequencer must be located within this directory in order to be loaded and/or played back.

### Counter:

The counter indicates the current position of the Sequencer within a MIDI song file.

#### a. Select a MIDI Song File Number:

To select a MIDI song file number, press the **MOVE** button to position the cursor on the MIDI Song File Number. Turn the **CHANGE** control knob to select a song number. Turning the knob clockwise will increase the file number while turning the knob counter-clockwise will decrease the file number. Any file number between 01 and 99 may be selected.



```
SEQUENCER PLAY #01  
00000  
PRESS [ACT] BUTTON
```

#### b. Delete a MIDI Song File Number:

To delete a MIDI song file number, press the **MOVE** button to position the cursor on the Sequencer Control Function.



```
SEQUENCER PLAY #01  
00000  
PRESS [ACT] BUTTON
```

Turn the **CHANGE** control knob to select the “DEL” control function.



```
SEQUENCER DEL #01  
00000  
PRESS [ACT] BUTTON
```

Select a MIDI Song File Number (see section 2a above).

When a MIDI Song File number has been selected, press the **ACT** button. The display will ask to confirm the selection: **N** = No, **Y** = Yes.



```
SEQUENCER DEL #08  
00000 CONFIRM:[N]Y  
PRESS [ACT] BUTTON
```

The currently selected option is located within the brackets.

To change the selected option, press the **MOVE** button. The brackets will toggle between the N and Y selections.



```
SEQUENCER DEL #08
00000 CONFIRM:NCY]
PRESS [ACT] BUTTON
```

To delete the selected MIDI Song file number, make sure that “Y” is selected (see above) and then press the **ACT** button.



```
SEQUENCER DEL #08
DELETING...
PRESS [ACT] BUTTON
```

To exit without deleting, make sure that “N” is selected and then press the **ACT** button.

```
SEQUENCER DEL #08
SUCCESSFUL!
PRESS [ACT] BUTTON
```



**Important!** If the selected MIDI song file number is not located, the display will indicate “FILE NOT FOUND!”

```
SEQUENCER DEL #08
FILE NOT FOUND!
PRESS [ACT] BUTTON
```

### c. Play a MIDI Song File

Press the **MOVE** button to position the cursor on the Sequencer Control Function.



```
SEQUENCER DEL #01
00000 →
PRESS [ACT] BUTTON
```

Turn the **CHANGE** control knob to select the “PLAY” control function.



```
SEQUENCER → PLAY #01
00000
PRESS [ACT] BUTTON
```

Select a MIDI Song File Number (*see section 2a*).

Open the expression shoe(s) to their maximum position and press the **ACT** button to begin playback. The counter will begin counting to indicate that playback has started and the Sequencer will display two additional transport functions: PAUS and STOP.



```
SEQUENCER PLAY #01
00XXX [PAUS] STOP
PRESS [ACT] BUTTON
```



**Important!** If a selected MIDI Song File is not located when playback is started, the display will indicate “FILE NOT FOUND!” and playback will not begin.

```
SEQUENCER PLAY #01
FILE NOT FOUND!
PRESS [ACT] BUTTON
```

To “pause” the Sequencer during playback, press the **ACT** button. The counter will stop counting and the instrument will stop playing indicating playback has stopped. The selected transport function will change to “CONT” indicating that playback can be “continued” from the current counter value.



```
SEQUENCER PLAY #01
00XXX [CONT] STOP
PRESS [ACT] BUTTON
```

**Note:** The counter value cannot be changed from its current value.

To continue playback, press the **ACT** button. The counter will begin counting from the current counter value and the instrument will begin playing indicating playback has resumed. The transport function will revert back to “PAUS” in case the organist needs to pause playback again.



```
SEQUENCER PLAY #01
00XXX [PAUS] STOP
PRESS [ACT] BUTTON
```

To stop playback, press the **MOVE** button to toggle the selection brackets to “STOP”.



```
SEQUENCER PLAY #01
00XXX PAUS [STOP]
PRESS [ACT] BUTTON
```

Press the **ACT** button to stop playback. The counter will reset to zero (0) and the instrument will stop playing indicating playback has stopped. The transport functions will also disappear.



```
SEQUENCER PLAY #01
00000
PRESS [ACT] BUTTON
```

#### d. To Record A MIDI Song:

Press the **MOVE** button to position the cursor on the Sequence Control Function.



```
SEQUENCER PLAY #01  
00000  
PRESS [ACT] BUTTON
```

Turn the **CHANGE** control knob to select the “REC” control function.



```
SEQUENCER REC #01  
00000  
PRESS [ACT] BUTTON
```

Select a MIDI Song File number  
(see section 2a).



**Hint!** To ensure the console setup information is recorded within a MIDI song, perform these steps after the recording has started:

1. Press the **CANCEL** piston. This will turn off any stops which are turned on and also transmit and record the currently selected capture memory level at the beginning of the MIDI song. Doing this will ensure the organ is set to the correct capture memory level when the MIDI song is played back preventing the potential for incorrect piston registrations to be selected.
2. Select a piston registration or manually select stops on the stopboard.
3. Move the expression shoe(s) and set them to a desired position. Doing this will record the organ’s volume information within the MIDI song. This way when a MIDI song is played back, the organ’s volume will be set to the correct level.

To begin the actual recording, press the **ACT** button. The counter will begin counting to indicate the Sequencer is now recording. At this point, begin playing the organ (see Hint! above). The Sequencer will display two additional transport functions: PAUS and STOP. Remember, all key, pedal, piston, stop or expression movements will be recorded.



```
SEQUENCER REC #01  
00XXX [PAUS] STOP  
PRESS [ACT] BUTTON
```



**Important!** If a selected MIDI Song File number already exists when a recording is started, the display will indicate “FILE EXISTS!” and recording will not begin. Delete the current selected MIDI song file number or select a different MIDI song file number to continue.

```
SEQUENCER REC #01  
FILE EXISTS!  
PRESS [ACT] BUTTON
```



To “pause” the Sequencer during a recording, press the **ACT** button. The counter will stop counting indicating recording has stopped. The selected transport function will change to “CONT” indicating that the recording can be “continued” from the current counter value.



```

SEQUENCER REC #01
00XXX [CONT] STOP
PRESS [ACT] BUTTON
    
```



**Important!** Any registration changes made to the organ while the recording has been paused will not be recorded!

**Note:** The counter value cannot be changed from its current value.

To continue recording, press the **ACT** button. The counter will begin counting from the current counter value indicating recording has resumed. The transport function will revert back to “PAUS” in case the organist needs to pause recording again.



```

SEQUENCER REC #01
00XXX [PAUS] STOP
PRESS [ACT] BUTTON
    
```

**Note:** Upon completion of a recording, press the **CANCEL** piston to turn off all of the stops and also move the expression shoes to their lowest position.

To stop recording, press the **MOVE** button to toggle the selection brackets to “STOP”.



```

SEQUENCER REC #01
00XXX PAUS [STOP]
PRESS [ACT] BUTTON
    
```

Press the **ACT** button to stop recording. The display will briefly flash “SAVING...” to indicate the MIDI Song File is being saved to the USB Flash Device. Once completed, the counter will reset to zero (00000) and the Sequence Control Function will automatically change to PLAY indicating the Sequencer is now ready to play the just recorded MIDI Song File.



```

SEQUENCER REC #01
SAVING...
PRESS [ACT] BUTTON
    
```



```

SEQUENCER PLAY #01
00000
PRESS [ACT] BUTTON
    
```

*(To play the MIDI Song File, see section 2c above)*

### e. PLAY+ (Playlist Playback)

The PLAY+ feature will playback a sequential list of MIDI songs recorded within the USB Flash Device. The Sequencer will begin playing all MIDI songs, in numerical order, starting with the MIDI file song number shown within the display. For example, if the MIDI file song number is set to “#5”, the Sequencer will begin with MIDI file song number #5 and then play all subsequent songs. When the Sequencer has reached the last MIDI song, playback will automatically stop.



**Important!** The Sequencer will stop playback if a MIDI Song number is missing within the sequential numbered file list. MIDI Song numbers must be contiguous.

To select the PLAY+ feature, press the **MOVE** button to position the cursor on the Sequencer Control Function.



Turn the **CHANGE** control knob to select the PLAY+ control function.

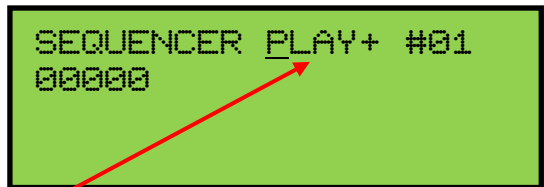

Select a MIDI Song File Number (*see section 2a above*). **Note:** The default selection is #1.

Open the expression shoe(s) to their maximum position and press the **ACT** button to begin playback. The counter will begin counting to indicate that playback has started and the Sequencer will display two additional transport functions: PAUS and STOP.

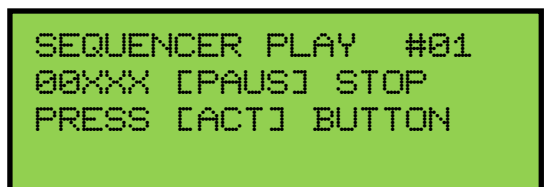

**Important!** If the selected MIDI song file number is not located when playback is started, the display will indicate “FILE NOT FOUND!” and playback will not begin. Select a different MIDI song file number to continue.



To “pause” the Sequencer during playback, press the **ACT** button. The counter will stop counting and the instrument will stop playing indicating playback has stopped. The selected transport function will change to “CONT” indicating that playback can be “continued” from the current counter value.



```
SEQUENCER PLAY+ #01
00XXX [CONT] STOP
PRESS [ACT] BUTTON
```

**Note:** The counter value cannot be changed from its current value.

To continue playback, press the **ACT** button. The counter will begin counting from the current counter value and the instrument will begin playing indicating playback has resumed. The transport function will revert back to “PAUS” in case the organist needs to pause playback again.



```
SEQUENCER PLAY+ #01
00XXX [PAUS] STOP
PRESS [ACT] BUTTON
```

To stop playback, press the **MOVE** button to toggle the selection brackets to “STOP”.



```
SEQUENCER PLAY+ #01
00XXX PAUS [STOP]
PRESS [ACT] BUTTON
```

Press the **ACT** button to stop playback. The counter will reset to zero (0) and the instrument will stop playing indicating playback has stopped. The transport functions will also disappear.



```
SEQUENCER PLAY+ #01
00000
PRESS [ACT] BUTTON
```

### 3. Capture Memory Registration Save/Load

All GeniSys™ instruments can both save and load capture registration data to the USB flash device. Capture registrations, piston configuration, MIDI settings, Crescendo/Tutti B settings and Piston Sequencer data (when applicable) can be saved and loaded using the GeniSys™ Controller when a USB flash device is inserted into the USB memory port.

To access the Capture Save feature, advance to the CAPTURE MEMORY window function (*see section A-2*).

```
CAPTURE MEMORY
SAVE ALL 01
PRESS [ACT] BUTTON
```



**Important!** A USB flash device must be inserted in the organ’s USB memory port for the capture save/load feature to be available.

The Capture Memory feature contains several display functions. Here is a quick breakdown of those functions and what they do:

**Mode Select:** LOAD, SAVE or DEL.

**LOAD:** Loads a selected capture file number.

**SAVE:** (3) options (**Type Select**):

“ALL” Saves all capture registrations, piston configuration, MIDI settings, Crescendo/Tutti B settings and Piston Sequencer data (when applicable).

“PCF” Saves only the piston configuration data.

“CRB” Saves only the Crescendo/Tutti B data.

**DEL:** Deletes the selected capture file number.

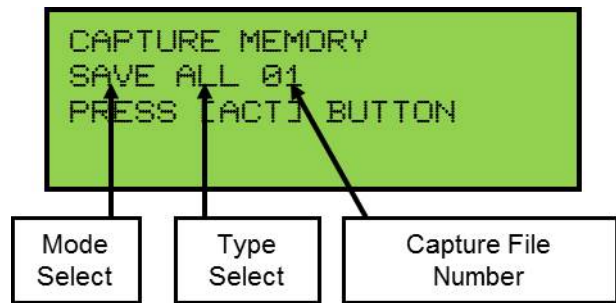

### a. Delete a Capture File

To delete an existing capture file number, press the **MOVE** button to position the cursor on the Mode Select value.



Turn the **CHANGE** control knob to select “DEL” mode.



Select a Capture File Number. Press the **MOVE** button to position the cursor on the Capture File Number value.

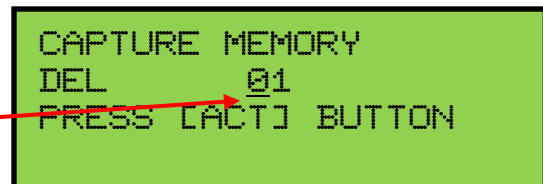

Turn the **CHANGE** control knob to select a capture file number. Turning the knob clockwise will increase the file number while turning the knob counter-clockwise will decrease the file number. Any file number between 01 and 99 may be selected.

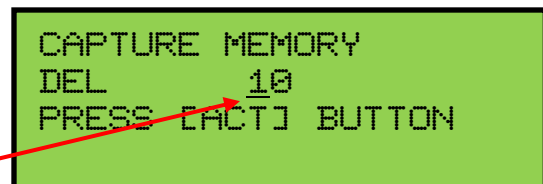

To delete the selected capture file number, press the **ACT** button.



```
CAPTURE MEMORY  
DEL    10  
PRESS [ACT] BUTTON
```



The display will briefly indicate when the file has been deleted and then return.

```
CAPTURE MEMORY  
SUCCESS!  
PRESS [ACT] BUTTON
```



**Important!** If the selected capture file number does not exist, the display will indicate “ERR NO SUCH FILE!” To continue, select a different capture file number.

```
CAPTURE MEMORY  
ERR NO SUCH FILE!  
PRESS [ACT] BUTTON
```

### b. Load a Capture File

To load an existing capture file number, press the **MOVE** button to position the cursor on the Mode Select value.



```
CAPTURE MEMORY  
SAVE ALL 01  
PRESS [ACT] BUTTON
```

Turn the **CHANGE** control knob to select “LOAD” mode.



```
CAPTURE MEMORY  
LOAD    01  
PRESS [ACT] BUTTON
```

Select a Capture File Number. Press the **MOVE** button to position the cursor on the Capture File Number value.



```
CAPTURE MEMORY  
LOAD    01  
PRESS [ACT] BUTTON
```

Turn the **CHANGE** control knob to select a capture file number. Turning the knob clockwise will increase the file number while turning the knob counter-clockwise will decrease the file number. Any file number between 01 and 99 may be selected.



```
CAPTURE MEMORY  
LOAD      10  
PRESS [ACT] BUTTON
```

To load the selected capture file number, press the **ACT** button.



```
CAPTURE MEMORY  
LOAD      10  
PRESS [ACT] BUTTON
```

The display will indicate when the file has been loaded and the capture system will turn off or cancel all stops when loading has completed.

```
CAPTURE MEMORY  
LOADING...  
PRESS [ACT] BUTTON
```

```
CAPTURE MEMORY  
SUCCESS!  
PRESS [ACT] BUTTON
```



**Important!** If the selected capture file number does not exist, the display will indicate “ERR NO SUCH FILE!” To continue, select a different capture file number.

```
CAPTURE MEMORY  
ERR NO SUCH FILE!  
PRESS [ACT] BUTTON
```

### c. Save a Capture File

To perform a capture save press the **MOVE** button to position the cursor on the Mode Select value.



```
CAPTURE MEMORY  
LOAD      01  
PRESS [ACT] BUTTON
```

Turn the **CHANGE** control knob to select “SAVE” mode.



```
CAPTURE MEMORY  
SAVE ALL 01  
PRESS [ACT] BUTTON
```

Select the Capture Save type. Press the **MOVE** button to position the cursor on the Type Select value.



```
CAPTURE MEMORY
SAVE ALL 01
PRESS [ACT] BUTTON
```

Turn the **CHANGE** control knob to select one of the (3) available Capture Save types: ALL, PCF or CRB (see section 3 above for a description of the different Capture Save types).



```
CAPTURE MEMORY
SAVE ALL 01
PRESS [ACT] BUTTON
```

Select a Capture File Number. Press the **MOVE** button to position the cursor on the Capture File Number value.



```
CAPTURE MEMORY
SAVE ALL 01
PRESS [ACT] BUTTON
```

Turn the **CHANGE** control knob to select a file number. Turning the knob clockwise will increase the file number while turning the knob counter-clockwise will decrease the file number. Any file number between 01 and 99 may be selected.



```
CAPTURE MEMORY
SAVE ALL 10
PRESS [ACT] BUTTON
```

To **SAVE** the selected capture data type, press the **ACT** button.



```
CAPTURE MEMORY
SAVE ALL 10
PRESS [ACT] BUTTON
```

The display will indicate the status of the capture save and when it has completed.



```
CAPTURE MEMORY
SUCCESS!
PRESS [ACT] BUTTON
```



**Important!** If a selected capture file number already exists when starting the save process, the display will indicate “ERR FILE EXISTS!” and the capture data save will not be saved. To continue, delete the current selected capture file number or select a different capture file number.

```
CAPTURE MEMORY
ERR FILE EXISTS!
PRESS [ACT] BUTTON
```

#### 4. Hymn Player (Classic models only)

GeniSys™ Classical instruments contain a Hymn Player which can play pre-recorded hymns contained on the factory supplied USB flash device.

**Note:** Additional hymns cannot be added to the existing list of available hymn selections.

To access the Hymn Player function, the factory supplied USB flash device must be inserted in the USB memory port before the organist can advance to and/or access the Hymn Player window function (*see Section A-2*).

```
_ A Mighty Fortress
Volume=10 Tempo=+00
Verses=2 Intro=no
Pitch=+0 [ACT]=Play
```



Line 1 of the display indicates the hymn song title and lines 2, 3 and 4 contain several playback parameters which the organist can adjust. To select a hymn, press the **MOVE** button to position the cursor on the hymn song title. Then, turn the **CHANGE** control knob to select a different hymn selection (*Hymns are arranged in alphabetical order*).



##### Playback Parameters:

To change the value of any of the playback parameters, press the **MOVE** button to position the cursor on any of the playback parameter values and adjust accordingly.

Volume: Sets the overall volume of the organ relative to the expression shoe position(s) for hymn playback. Volume range is 1 (softest) through 10 (loudest).

*Note: Volume cannot be adjusted during playback.*

Tempo: Increase or decrease tempo by positioning the cursor on the Tempo value and then turn the **CHANGE** control. Tempo may be adjusted up or down in increments of 10. Maximum tempo value is plus/minus 50.

Verses: Change the number of verses by positioning the cursor on the Verse value and then turn the **CHANGE** control. Maximum number of verses is 9.

Intro: Determines whether an Introduction passage is played before the hymn. Position the cursor on the Intro value and then turn the **CHANGE** control to select yes or no.

*Note: Intro value cannot be changed during playback.*

Pitch: Raise or lower the pitch by positioning the cursor on the Pitch value and then turn the **CHANGE** control. Pitch may be raised or lowered in half-step increments. Standard Transposer range is applicable; pitch can be raised a maximum of five half-steps or lowered a minimum of seven half-steps.

*Note: Pitch value cannot be changed during playback.*



To begin hymn playback, press the **ACT** button. The display will indicate the current verse number playing.



Both the Tempo and number of Verses may be adjusted during hymn playback. Press the **MOVE** button to position the cursor on either the Tempo or Verses value. Then, turn the **CHANGE** control knob to change the value.



To stop hymn playback at any time, press the **CANCEL** piston.





To return to the *Main Window* function, press and hold the **SET** piston. Then, while holding **SET**, press the **CANCEL** piston. Release both.

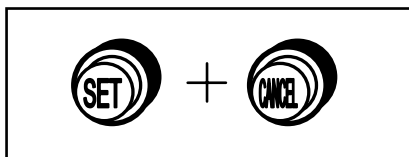

**Note:** You can change the organ's registration at any time during playback, either manually or by using pistons. However, the registration will return to the hymn player default at the beginning of each verse.

## 5. Prelude Player

GeniSys™ instruments contain a Prelude Player which can play pre-recorded Preludes contained on the factory supplied USB flash device.

**Note:** Additional Preludes cannot be added to the existing list of available Prelude selections.

To access the Prelude Player function, the factory supplied USB flash device must be inserted in the USB memory port before the organist can advance to and/or access the Prelude Player window function (*see Section A-2*).

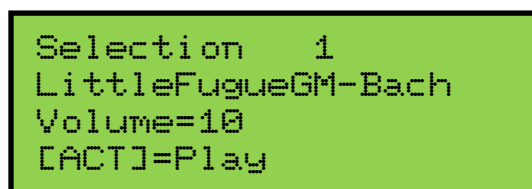

Line 1 displays the Prelude Selection number; line 2 displays the Prelude name.



To select a Prelude, press the **MOVE** button to position the cursor on the Prelude Selection number. Then, turn the **CHANGE** control knob to select a different Prelude selection. The Prelude name will change with the selection number.



To adjust the volume of the Prelude, press the **MOVE** button to position the cursor on the volume value. Then, turn the **CHANGE** control knob to adjust the value. Volume range is 1 (softest) through 10 (loudest).

**Note:** Volume cannot be adjusted during playback.



To begin playing the Prelude, press the **ACT** button.

To stop playing the Prelude, press the **CANCEL** piston.



## C. ADVANCED OPERATION

### 1. Selecting an Alternate Tuning

Advance to the 'ALTERNATE TUNING' window function (*see section A-2*).

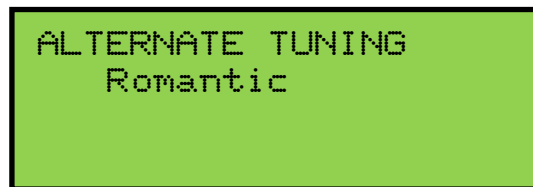

(The current Alternate Tuning will appear on line 2 of the display)



Allen Organs offer eight *Alternate Tunings*, plus one standard tuning. These tunings are accessible from the GeniSys™ Controller. To select an *Alternate Tuning*, press the **MOVE** button on the GeniSys™ Controller until the cursor is positioned on the Alternate Tuning name (*line 2*). Turn the **CHANGE** control knob to select one of the eight available tunings. The organ's overall tuning will be changed to the selected *Alternate Tuning*, by actuating the stop control engraved "ALTERNATE TUNING".



The selected tuning will remain the *Alternate Tuning* until:

- ❑ Another *Alternate Tuning* is selected in the GeniSys™ Controller,
- ❑ Or, the stop control is turned off.

Any time the ALTERNATE TUNING stop is off, the organ reverts to a standard general purpose tuning. **Note:** *The remaining tunings are of historical interest, but are limited in application to modern music. When selected, it is normal for some intervals to sound out of tune.*

#### Alternate Tunings:

1. Romantic
2. Classic
3. Baroque
4. Kirnberger 3
5. Werckmeister 3
6. Just Intonation
7. Young 2
8. Pythagorean

## 2. Configuring General Pistons

This procedure enables pistons to control stops that are normally not controlled by those pistons.

**Important!** The Piston Configuration is common to all capture memories.

For example:

- (1) Pistons can be configured to control only certain specific stops.
- (2) A piston can be configured so that it will only affect the Tremulant stops.
- (3) A General piston can be configured to respond like a Divisional Piston.

**Note 1:** Changing the configuration of a piston *will not affect the registrations* previously remembered by that piston prior to its reconfiguration.

**Note 2:** Reconfiguring a piston does not change its MIDI channel assignment.

### Configuring General Pistons to only affect MIDI stops:

Advance to the 'CONFIGURE PISTONS' window function (*see section A-2*).

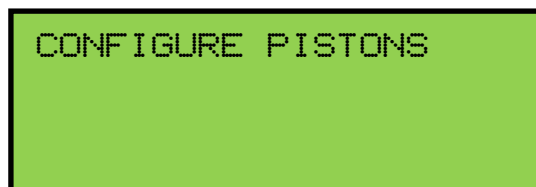

At this point, pressing any piston will actuate stops controlled by that particular piston.

### EXAMPLE CONFIGURATIONS

#### To reconfigure a piston to control only the MIDI stops:

Select just the MIDI stop controls. Press and hold the **SET** piston. Then, while holding **SET**, press a General piston that you want only the MIDI stops to respond on. Release both. The General piston just pressed will now only be able to program the MIDI stop controls and will no longer affect other stops.

#### To reconfigure a General Piston so it controls only the Swell Division stops:

Select *all* of the Swell division stops. Press and hold the **SET** piston. Then, while holding **SET**, press a General piston that you want only the Swell division stops to respond on. Release both. The General piston just pressed will now only be able to program the Swell division stops and will no longer affect other stops.

#### To add the “Swell To Great” Intermanual Coupler to the Great Divisional Pistons:

Select *all* of the Great Division stops controls and also the “Swell To Great” intermanual coupler. Press and hold the **SET** piston. Then, while holding **SET**, press each Great Divisional Piston, in sequence while holding **SET**. Release **SET** when completed. The “Swell To Great” coupler can now be registered to the Great Divisional pistons.

#### To reconfigure a General/Divisional Piston so it controls only the Tremulant stops:

Select *all* of the organ’s Tremulant sop controls. Press and hold the **SET** piston. Then, while holding **SET**, press a General/Divisional piston. The General/Divisional piston just pressed will now only be able to program the Tremulant stops and will no longer affect other stops.

To return to the *Main Window* to store registrations to the pistons you just configured, press and hold the **SET** piston. Then, while holding **SET**, press **CANCEL**. Release both. (See Section A-4).

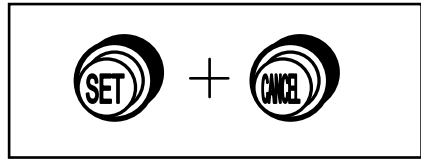

The use of the CONFIGURE PISTONS function is only limited by one's creative imagination.

**Remember:** The above examples only determine which stops will become accessible by the reconfigured pistons; *they will not change any previously saved registrations.*

### 3. Restoring Original Factory Settings

Advance to the 'RE-INITIALIZE' window function (see Section A-2). The window will display...



Certain functions can be restored to the original factory settings. They are:

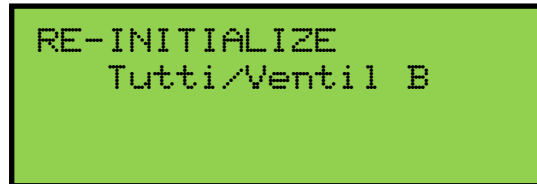
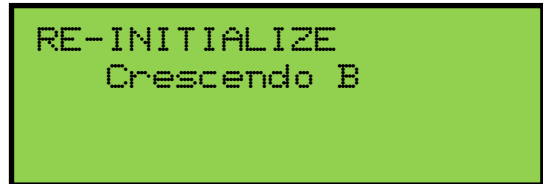
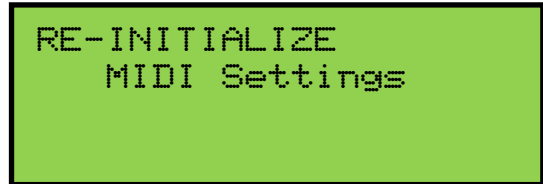

The Piston Configuration re-initialization includes all the Configure Piston settings. The MIDI Settings re-initialization includes all MIDI program change mapping. The Capture Memory re-initialization will reset the last available capture memory to factory default registrations (*if applicable*).



Each of these functions can be restored individually. To select the factory settings you wish to restore, press the **MOVE** button until the cursor is positioned on the parameter value located on the 2<sup>nd</sup> line of the display. Then, turn the **CHANGE** control knob to select the desired setting to re-initialize.



Press and hold the **ACT** button. Then, while holding **ACT**, press General Pistons 2-5-5 in sequence.

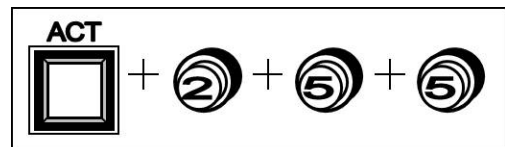

The display will briefly flash the word "WORKING" on the second line of the display to indicate that the current command function is being re-initialized.

#### 4. Global Tuning

Global Tuning allows the organist to adjust the pitch of the entire organ. This tuning adjustment allows the organ to be tuned to another instrument more easily. Tuning can be adjusted either  $\pm 100$  cents from A-440 pitch. To adjust Global Tuning, advance to the 'GLOBAL TUNING' window function (*see Section A-2*).

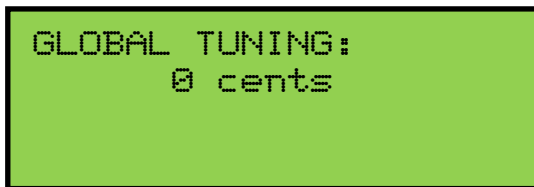

Press the **MOVE** button to position the cursor on the tuning value. Turn the **CHANGE** control knob in either direction to raise or lower the pitch of the organ. Turning the knob clockwise will raise the pitch while turning the knob counter-clockwise will lower the pitch.

**Note:** The Global Tuning adjustment will be retained in memory when the organ is powered off.

#### 5. Headphone Volume (*REN-25 based instruments and only if the Headphone feature is enabled*)

The master headphone volume control is integrated into the GeniSys™ Controller. Adjusting this setting will change the overall output volume level of the headphone in relation to the organ's expression pedal. To adjust the headphone volume, advance to the "HEADPHONE MASTER" window function (*see Section A-2*).

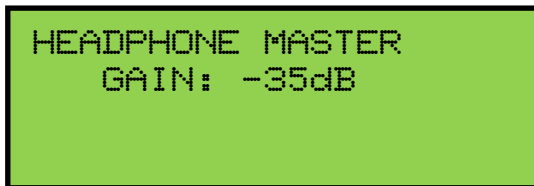

To change the Headphone Master Gain setting, press the **MOVE** button to position the cursor on the Gain setting value. Turn the **CHANGE** control knob to change the gain setting. Gain adjustment range is from (off) or minus 35dB to 6db. Minus 35db is the least amount of gain while 6db is the most or maximum amount of gain.

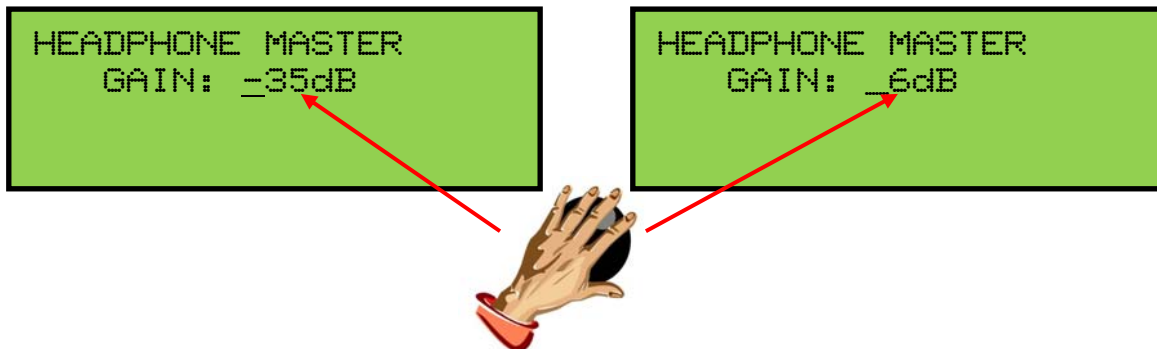

## 6. Sostenuto (optional)

*Sostenuto* is an Italian word meaning “sustained.” Unlike the sustain switch, which sustains any notes played as long as the sustain switch is held on, the *Sostenuto* switch sustains only the notes being held at the very moment it is pressed. *Sostenuto* is actuated by the organ’s MIDI Sustain switch (which is optional on some organs) located to the left of the Great/Pedal expression shoe. The *Sostenuto* function must first be enabled before using it.

Advance to the ‘SOSTENUTO’ window function (*see Section A-2*).



The display will indicate which manual *Sostenuto* is assigned to and indicate the current on/off status.

**Note:** The manual which *Sostenuto* is assigned to cannot be changed, but the on/off status can.

To change the status of the *Sostenuto* function, press the **MOVE** button to position the cursor on the on/off value.

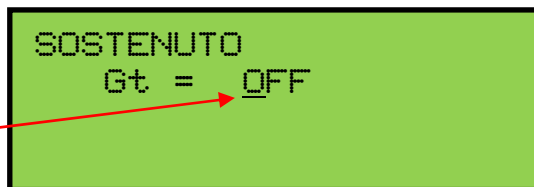

Then, turn the **CHANGE** control knob to change the on/off status.



**Important!** *Sostenuto* will affect the internal voices of the organ as well as a MIDI instrument connected to the MIDI output. Keep in mind that the Sustain function will operate in tandem with the *Sostenuto* function.

**Note:** Check your specific MIDI instrument’s owner’s manual to verify that it will receive and/or respond to MIDI *Sostenuto* messages.

## 7. Piston Sequencer (optional)

The Piston Sequencer allows the organist to step through a sequence of registrations using piston/toe studs labeled "+" and "-". The Piston Sequencer is accessed and enabled through the *Main Window* function. Four modes of operation are available.

**OFF:** The Piston Sequencer is disabled. The "+" and "-" pistons/toe studs will not function.

**SIMPLE STEPPER:** This mode allows the organist to step sequentially through the available General pistons of a single capture memory level.

**ADVANCED STEPPER:** This mode allows the organist to step sequentially through the available General pistons of all capture memory levels.

**CUSTOM SEQS:** This mode allows the organist to step sequentially through a user programmed piston sequence of any available piston and capture memory level. Piston Sequence memory allows 512 steps allocated to a maximum of 99 sequences.

**Note:** Custom piston sequence data will be saved to the USB flash device when selecting the ALL capture data type option when saving capture memory registration data (*see section B-3 in this manual for more information*).

### **OFF MODE**

To select the OFF mode, press the **MOVE** button to position the cursor on the Piston Sequencer value.

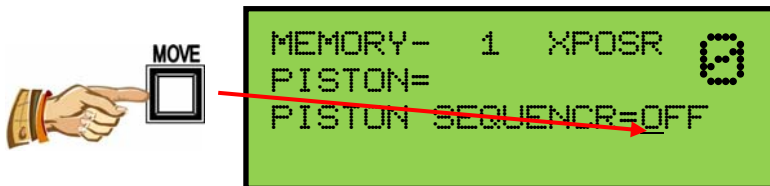

**Note:** The organ will remember the Piston Sequencer mode setting when power is turned off. If Piston Sequencer was previously enabled previously, OFF mode may be selected to disable the Piston Sequencer.

Turn the **CHANGE** control knob to select OFF mode.



## SIMPLE STEPPER MODE

To select the SIMPLE STEPPER mode, press the **MOVE** button to position the cursor on the Piston Sequencer value.



```
MEMORY- 1 XPOSR  [a]
PISTON=
PISTON SEQUENCER=OFF
```



Turn the **CHANGE** control knob to select SIMPLE STEPPER mode.

SIMPLE STEPPER = “SMPL”

```
MEMORY- 1 XPOSR  [a]
PISTON=
PISTON SEQUENCER=SMPL
```

To use SIMPLE STEPPER, first reset the cursor position by pressing and holding the **SET** piston. Then, while holding **SET**, press **CANCEL**. Release both pistons.

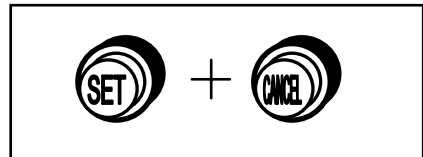

## USING THE SIMPLE STEPPER

If SIMPLE STEPPER mode is activated, using the pistons/toe studs labeled “+” or “—”, SIMPLE STEPPER will step up or down sequentially through all General Piston positions within the selected capture memory level, stopping when either extreme is reached.

To start SIMPLE STEPPER, select a capture memory level (*see Section A-3*) and then press General piston #1. The registration associated with the selected capture memory level and General piston #1 will register on the stops and the display will indicate that General #1 has been pressed. This will also set SIMPLE STEPPER’s starting step position.

```
MEMORY- 1 XPOSR  [a]
PISTON=Gen 1
PISTON SEQUENCER=SMPL
```

**Note:** Pressing the “+” or “—” piston will also select General #1 and also set SIMPLE STEPPERS starting step position.

Pressing the “+” piston/toe stud will select the next General piston number, in this case General Piston #2.

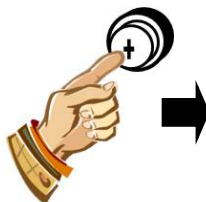

```
MEMORY- 1 XPOSR  [a]
PISTON=Gen 2
PISTON SEQUENCER=SMPL
```

**Remember!** If General #1 is displayed, the “—” piston will do nothing since General #1 is the lowest possible General piston number available.



SIMPLE STEPPER's step position may be changed at any time, on-the-fly, by pressing a different General piston than the one displayed. SIMPLE STEPPER will then step up or down from the newly selected General piston number when either the "+" or "-" piston/toe stud are pressed.

For example; if the SIMPLE STEPPER's current step position is General #4, pressing General #7 will not only change the registration, but will also set the SIMPLE STEPPER's step position to General #7. At this point, pressing either the "+" or "-" piston/toe stud will step up or down from General #7.

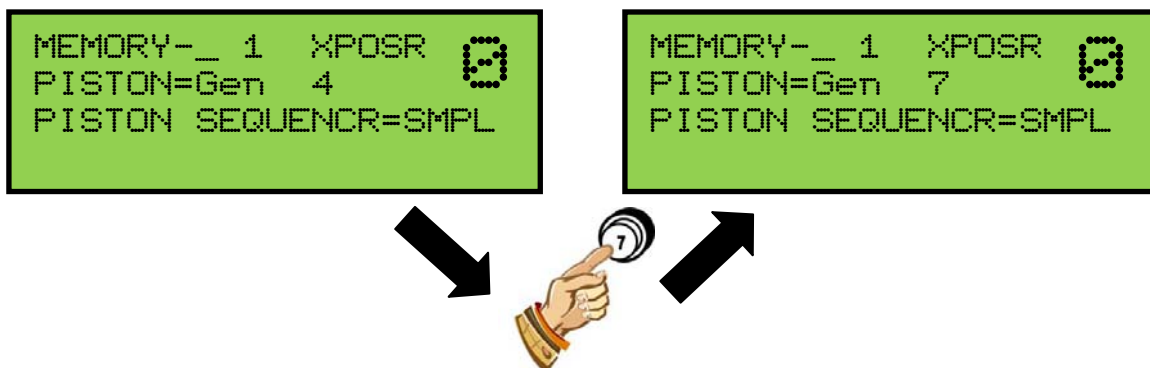

The capture memory level may also be changed at any time while within SIMPLE STEPPER mode. To change the capture memory level, press the **MOVE** button to position the cursor on capture memory level value. Then, turn the **CHANGE** control knob to select a different capture memory level (*see Section A-3*).



**Important!** Changing the capture memory level will reset the SIMPLE STEPPER's step position value back to General #1. The organist will need to select a new starting step position by selecting and pressing a General piston or the organist can automatically start at General #1 by pressing the "+" or "-" piston/toe stud.

SIMPLE STEPPER will remember the last General piston pressed and will resume stepping from that step position based on whether the "+" or "-" piston/toe stud is pressed. Even if the **CANCEL** piston is pressed and the piston display cleared and/or a Divisional piston is pressed, SIMPLE STEPPER will remember the last General piston pressed and will resume stepping from that step position.

**Example #1:** General #5 is the current selected General piston. The organist presses CANCEL. The organist then presses the "+" piston. The piston display now indicates General #6 and sets the registration accordingly.

Scenario: General #6 was selected because General #5 was the last active General piston before CANCEL was pressed and even though the piston display was blank.

## ADVANCED STEPPER MODE

To select the ADVANCED STEPPER mode, press the **MOVE** button to position the cursor on the Piston Sequencer value.



```
MEMORY- 1 XPOSR  6
PISTON=
PISTON SEQUENC=OFF
```



Turn the **CHANGE** control knob to select ADVANCED STEPPER mode.

ADVANCED STEPPER = “ADV”

```
MEMORY- 1 XPOSR  6
PISTON=
PISTON SEQUENC=ADV
```

To use ADVANCED STEPPER, first reset the cursor position by pressing and holding the **SET** piston. Then, while holding **SET**, press **CANCEL**. Release both pistons.

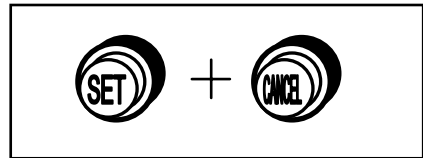

## USING THE ADVANCED STEPPER

If the ADVANCED STEPPER mode is active, using the pistons/toe studs labeled “+” or “-”, ADVANCED STEPPER will step up or down sequentially through all General Piston positions and through all capture memory levels, stopping when either extreme is reached.

To start ADVANCED STEPPER, select a capture memory level (*see Section A-3*) and then press General piston #1. The registration associated with the selected capture memory level and General piston #1 will register on the stops and the display will indicate that General #1 has been pressed. This will also set ADVANCED STEPPER’s starting step position.

```
MEMORY- 1 XPOSR  6
PISTON=Gen 1
PISTON SEQUENC=ADV
```

**Note:** Pressing the “+” or “-” piston will also select General #1 and also set ADVANCED STEPPERS starting step position.

Pressing the “+” piston/toe stud will select the next General piston number, in this case General Piston #2.

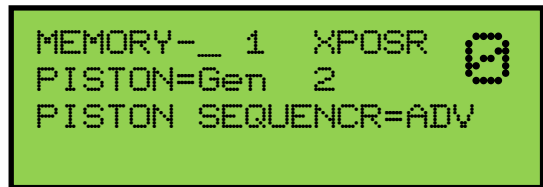
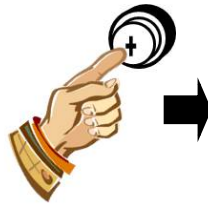

**Remember!** If capture memory level #1 is selected and General #1 is displayed, the “—” piston will do nothing since General #1 is the lowest possible General piston number available.

Pressing the “+” piston/toe stud will begin stepping through each General piston number from the starting step position within the selected capture memory level. When the last General piston is reached and the “+” piston is pressed, the capture memory level value will increment by one (1) and General #1 will be selected within the next highest capture memory level. The same is true in reverse when the “—” piston is pressed. However, when General #1 is reached and the “—” piston is pressed, the capture memory level will decrement by one (1) and the last General piston will be selected within the next lowest capture memory level.

As with SIMPLE STEPPER, ADVANCED STEPPER’s step position may be changed at any time, on-the-fly, by selecting a different capture memory level and/or also by pressing a different General piston other than the one displayed within the selected capture memory level. ADVANCED STEPPER will then step up or down from the newly selected capture memory level and/or General piston number when either the “+” or “—” piston/toe stud are pressed.

To change the capture memory level, press the **MOVE** button to position the cursor on capture memory level value. Then, turn the **CHANGE** control knob to select a different capture memory level (*see Section A-3*).



**Important!** Changing the capture memory level will reset ADVANCED STEPPER’s step position back to General #1 within the newly selected capture memory level. The organist will need to select a new starting step position by selecting and pressing a General piston or the organist can automatically start at General #1 by pressing the “+” or “—” piston/toe stud.

To select a different General piston as a starting step position within the current capture memory level, simply press another General piston number.

ADVANCED STEPPER will also remember the last General piston pressed and will resume stepping from that step position based on whether the “+” or “—” piston/toe stud is pressed. Even if the **CANCEL** piston is pressed and the piston display cleared and/or a Divisional piston is pressed, ADVANCED STEPPER will remember the last General piston pressed and will resume stepping from that step position.

**Example #2:** General #9 is the current selected General piston. The organist presses Swell Divisional piston #4 to change only the Swell registration briefly (Sw 4 is shown within the piston display) and then presses the “+” piston to continue. The piston display indicates General #10 and sets the registration accordingly.

**Scenario:** General #10 was selected because General #9 was the last active General piston before Swell Divisional #4 was pressed. Divisional pistons are not recognized as valid step positions when using either the SIMPLE or ADVANCED STEPPER modes.

## CUSTOM SEQUENCE MODE

To select the CUSTOM SEQUENCE mode, press the **MOVE** button to position the cursor on the Piston Sequencer value.



```
MEMORY- 1 XPOSR 6
PISTON=
PISTON SEQUENC=OFF
```



Turn the **CHANGE** control knob to select CUSTOM SEQUENCE mode.

CUSTOM SEQUENCE = "CUS"

```
MEMORY- 1 XPOSR 6
PISTON=
PISTON SEQUENC=CSTM
SEQUENCE=001 STEP=01
```

To use a CUSTOM SEQUENCE, first reset the cursor position by pressing and holding the **SET** piston. Then, while holding **SET**, press **CANCEL**. Release both pistons.

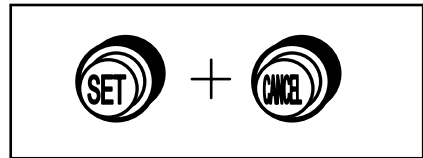

A custom piston sequence is completely programmable by the organist. Each step position is assigned a capture memory level, General or Divisional manual piston assignment and a piston number. This gives the organist the flexibility to be able to switch capture memory levels and piston assignments between each step position. The custom piston sequence can then be maneuvered sequentially through each programmed step by using the "+" or "-" piston buttons, stopping when either extreme is reached.

## CUSTOM PISTON SEQUENCE EDITING FUNCTIONS

Custom Piston Sequences are created and modified within a special editing window function which precedes the *Main Window* function within the GeniSys™ Controller.

**Note:** The 'CUSTOM SEQUENCE' editing window function is only available if Custom Sequence mode is enabled.

There are four different editing functions available:

**INSERT:** Insert allows the organist to enter a new sequence or a new step within an existing piston sequence.

**EDIT:** Edit allows the organist to make changes to existing programmed steps. Capture memory level, piston division, and piston number may be edited within any step position.

**SHOW:** Show allows the organist to step through a piston sequence viewing the capture memory level, piston, and stop registration of each step.

**DELETE:** Delete allows the user to remove an existing sequence or step within a piston sequence.

## INSERT--CREATING A NEW CUSTOM SEQUENCE OR STEP

To advance to the Custom Sequence edit window function, make sure the *Main Window* function is displayed (see Section A-2). Then, make sure CUSTOM SEQUENCE mode is selected (see Section C-7) and that the cursor is then positioned on the “Menu Function” (see Section A-2). Turn the **CHANGE** control knob counter-clockwise to access the Custom Sequence edit window function.

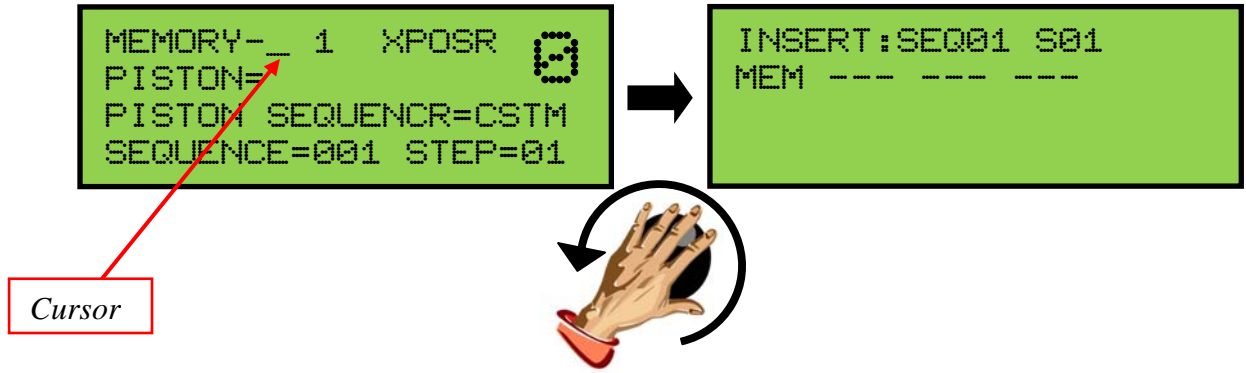

**Note:** If the organ does not contain any custom sequences, the editing window will automatically default to the INSERT mode. However, if the organ does contain custom sequences, the editing window will default to the EDIT mode.

To enter the INSERT mode, press the **MOVE** button to position the cursor on the editing function.

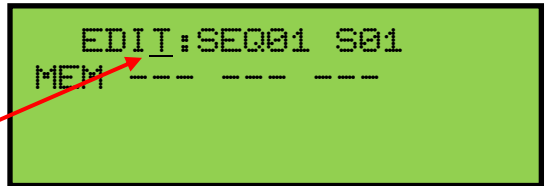

Turn the **CHANGE** control knob to select "INSERT" mode.



There are several available data fields within the Custom Sequence editing windows. The organist has access to the custom sequence number, step position number, capture memory level, piston division assignment and piston number.

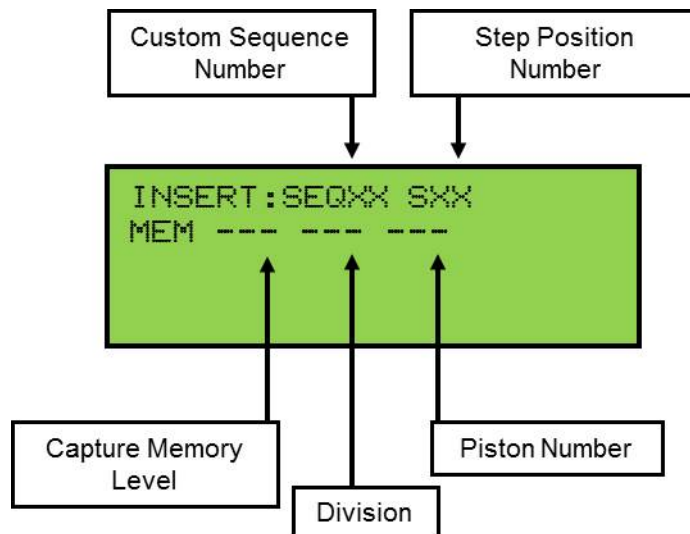



Use the **MOVE** button to position the cursor on a data field and the **CHANGE** control knob to select a desired value. Blank positions indicate the specified Sequence and Step have no programmed contents. Enter values for the Seq#, Step#, capture memory level, division and piston number.

```
INSERT:SEQ01 S01
MEM    1 Gen    8
```



Once the desired values have been set, use the **SET** piston and **ACT** button to save the data to the selected step position. "DONE!" will briefly flash on the display to indicate the current step position has been successfully saved to memory. Continue adding steps and sequences as desired.

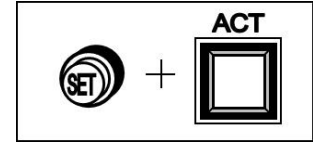

```
INSERT:SEQ01 S01
      DONE!
```

In addition to creating a new piston sequence, the INSERT mode can add step positions into an existing piston sequence. To do this, using the MOVE button/CHANGE control knob, select an existing piston sequence number and step position number to insert a new step.

**Note:** If the step position number is positioned on the last step of the selected piston sequence, no higher step number may be selected. The step will be appended to the end of the piston sequence.

Select the desired values for the capture memory level, division and piston number. Use the **SET** piston and **ACT** buttons to save the selected data. "DONE!" will briefly flash on the display to indicate the step position has been successfully saved to memory.

**Note:** Inserting and saving a new step position will move all subsequent steps within the piston sequence up by one step position.



**Important!** Do not use the INSERT mode to edit a step position. INSERT will only add steps into a piston sequence at the selected step position.

### EDITING AN EXISTING STEP POSITION

To enter the EDIT mode, press the **MOVE** button to position the cursor on the editing function.



```
INSERT:SEQ01 S01
MEM    1 Gen    8
```



Turn the **CHANGE** control knob to select "EDIT" mode.

```
EDIT:SEQ01 S01
MEM    1 Gen    8
```

Using the MOVE button/CHANGE control knob; select a piston sequence number and step position number to be changed. Then, select and edit the desired capture memory level, division and piston number. Use the SET piston and ACT button to save the edited data. "DONE!" will briefly flash on the display to indicate the edited step position has been successfully saved to memory.

**DELETING A CUSTOM SEQUENCE OR SINGLE STEP POSITION**

To enter the DELETE mode, press the MOVE button to position the cursor on the editing function.

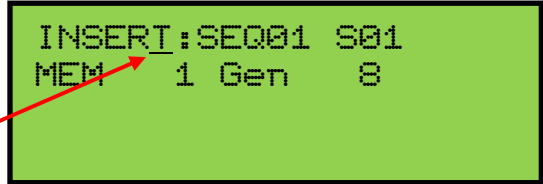

Turn the CHANGE control knob to select "DELETE" mode.

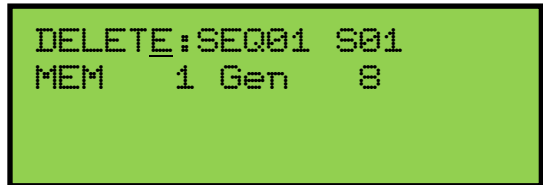

Using the MOVE button/CHANGE control knob, select a custom sequence number and/or step position number that is to be deleted.



**Important!** The cursor position determines whether a single step position or an entire custom sequence is deleted.

- If an entire piston sequence is to be deleted leave the cursor positioned within the custom sequence number field.
- If a step position within a custom sequence is to be deleted leave the cursor positioned within the step position field.

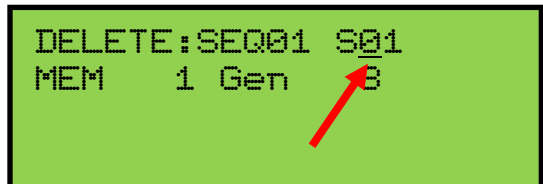
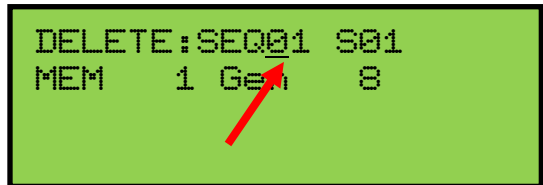

**Check the CURSOR POSITION!!** DELETE cannot be undone once it has been performed.

Use the SET piston and ACT button to delete the selected data. "DONE!" will briefly flash on the display to indicate the selected data has been deleted successfully.



**Note:** Deleting a step position within the middle of a piston sequence will cause all subsequent steps to shift down by one step position. Empty step positions are not allowed.

**Note:** Deleting all piston sequences from memory will cause the organ to automatically enter the INSERT mode while within the editing window.

## SHOWING/PREVIEWING A PISTON SEQUENCE

To enter the SHOW mode, press the **MOVE** button to position the cursor on the editing function.



```

EDIT:SEQ01 S01
MEM 1 Gen 8
    
```

Turn the **CHANGE** control knob to select "SHOW" mode.

```

SHOW:SEQ01 S01
MEM 1 Gen 8
    
```



Using the MOVE button/CHANGE control knob, first select a custom sequence number and then a step position to be viewed. Use the CHANGE control knob to change the step position number. As the step position counter changes the selected step position's programmed data will appear within the display and will also be reflected on the organ's stop controls.

Show mode is provided as a "shortcut". Instead of exiting out of the editing window to view a custom sequence, the contents of custom sequences may be viewed from within the edit window function. Show mode displays step positions and programmed data within the display. Stop controls operate showing the registration saved for each step position. The organist can toggle back and forth between the editing modes by using the MOVE button and CHANGE control knob to make changes to the custom sequence.

## USING A CUSTOM PISTON SEQUENCE

To use a custom piston sequence, make sure that the Custom Sequence mode is selected (*see Sections C-7*). The display will indicate the Custom Sequence mode is selected as well as the piston sequence number and step position (see below).

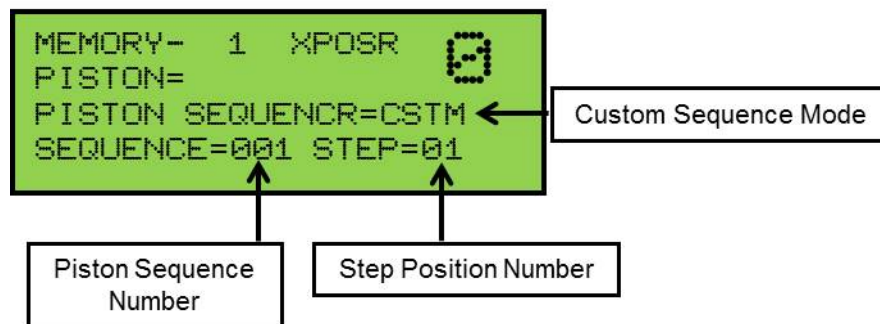

From here, the organist can select a custom piston sequence to use and step position. The capture memory level and piston display will reflect the programmed data within the selected step position number.

To select a piston sequence number, press the **MOVE** button to position the cursor on the piston sequence number.



```

MEMORY- 1 XPOSR
PISTON=
PISTON SEQUENCR=CSTM
SEQUENCE=001 STEP=01
    
```





Then, turn the **CHANGE** control knob to select a piston sequence number.

To select a step position, press the **MOVE** button to position the cursor on the step position number.



```
MEMORY- 1 XPOSR  9
PISTON=
PISTON SEQUENCR=CSTM
SEQUENCE=001 STEP=01
```



Then, turn the **CHANGE** control knob to select a starting step position. Press the “+” or “—” piston/toe stud to start the custom sequence at the selected step position. The capture memory level and piston display will reflect the programmed data within the selected step position number and the registration will be reflected on the organ’s stop controls.

Use the “+” and “—” pistons/toe studs to step up or down through the piston sequence. If at any time a different piston/toe stud is selected “out of sequence”, the piston display will indicate a piston/toe stud was selected which is not within the programmed custom sequence (*see illustration*).

Selecting a piston/toe stud out of the programmed sequence will not change the step position counter value, only the registration of the selected piston/toe stud will be reflected on the organ’s stop controls. To continue stepping through the custom sequence simply press the “+” or “—” piston/toe studs and the custom sequence will resume at the next programmed step position.

*Out of Sequence*

```
MEMORY- 1 XPOSR  9
PISTON=Gen 4*
PISTON SEQUENCR=CSTM
SEQUENCE=001 STEP=05
```

## D. MIDI FUNCTIONS

This section explains the MIDI capabilities of your Allen Organ. Knowledge of this section is **not** required for everyday use of the organ, normal service playing, or use of Allen SmartMIDI™ devices. This information's usefulness will ultimately be determined by your needs, along with the type and capabilities of any external MIDI devices you choose to use--e.g., sequencers, voice/sound modules and external MIDI keyboards. The MIDI topics covered by this manual are limited in scope. You need to understand the terms MIDI IN, OUT and THRU and their basic functions. To increase your understanding of MIDI and its capabilities it is suggested that you will need to read books or literature which describe how to use MIDI. See Section D later in this manual for more information regarding MIDI.

**Note:** You must also consult the owner's manual that covers the external MIDI device(s) you are using for more details of their operation.

### 1. Standard MIDI Channel Assignments

These are the Allen Organs' standard MIDI channels settings:

Classic Models (2, 3 or 4 Manuals)			Theatre Models (2 or 3 Manuals)		
Channel	=	Organ Division	Channel	=	Organ Division
1	=	Swell	1	=	Great
2	=	Great	2	=	Accomp.
3	=	Pedal	3	=	Pedal
4	=	Choir	4	=	Solo
5	=	Solo	5	=	Acc. 2 <sup>nd</sup> Touch
6	=	<i>n/a</i>	6	=	Gt. 2 <sup>nd</sup> Touch
7	=	G1/G2	7	=	T1/T2
8	=	General	8	=	General

**Note:** The MIDI Base Channel always resets to Channel 1 whenever the organ is turned on (*see section C-5*).

### 2. Selecting Program Change Modes

Program change modes establish how MIDI program changes will be sent from the organ when a piston is pressed and what the resulting display will be within the GeniSys™ Controller LCD. Once a particular program change mode is selected, the organ will retain this same program change mode (even when the organ is turned off) until a new program change mode is selected. These three mode options determine how the organ sends program change information to MIDI devices.

## Selecting a Program Change Mode

Advance to the 'PROG CHANGE' window function (*see Section A-2*). It will display:

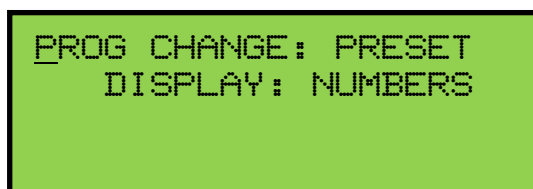

```
PROG CHANGE: PRESET
DISPLAY: NUMBERS
```

Press the **MOVE** button until the cursor is positioned on the Program Change mode value.



Turn the **CHANGE** control knob to select either "Preset", "User" or "No" modes.



**Important!** You must understand how to operate and when to use each of these modes before you change them!



**PRESET** Mode: This mode causes the organ to send a program change number equal to the piston number that is pressed. Preset mode also allows the organ to transmit the capture memory level value whenever the capture memory level is changed or whenever the CANCEL piston is pressed. The General Pistons will send program changes 1-10 on MIDI Channel 8, the organ's General Piston control channel. The Divisional Pistons for each division will send program changes on the respective MIDI channels as shown on the previous page. For example, Swell Piston 1 will send Program Change 1 on MIDI Channel 1. Great Piston 2 will send Program Change 2 on MIDI Channel 2, etc. (*See Section D-6*).

**USER** Mode: In this mode, the organ is capable of sending any program change number on any piston that will select voices, change banks, or change program "patch" numbers on another MIDI device. Any MIDI program change number from 1 through 128 can be assigned to any General or Divisional Piston (blank or no digit may also be selected). Any MIDI bank switch number between 0 and 127 can be assigned to any Divisional Piston. As in PRESET mode, General Pistons will send program change information on MIDI Channel 8. Divisional Pistons will send program change information on their respective MIDI channels. (*See Section D-6*)

**Note:** The capture memory level value is not transmitted while in USER mode.

**NO** Mode: With this mode selected, NO program change information is either transmitted or received.

### 3. General MIDI Sound Names or Program Numbers

The GeniSys™ Controller™ can display MIDI program changes as either MIDI program numbers or as General MIDI sound names while in USER Program Change mode. First, make sure the Program Change mode is set to USER (*see section D-2*). Press the **MOVE** button to position the cursor on the Display mode value.

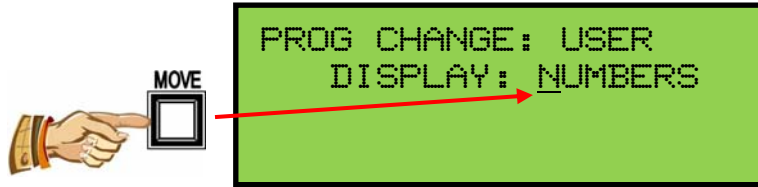

Then, turn the **CHANGE** control knob to select one of the two available modes.

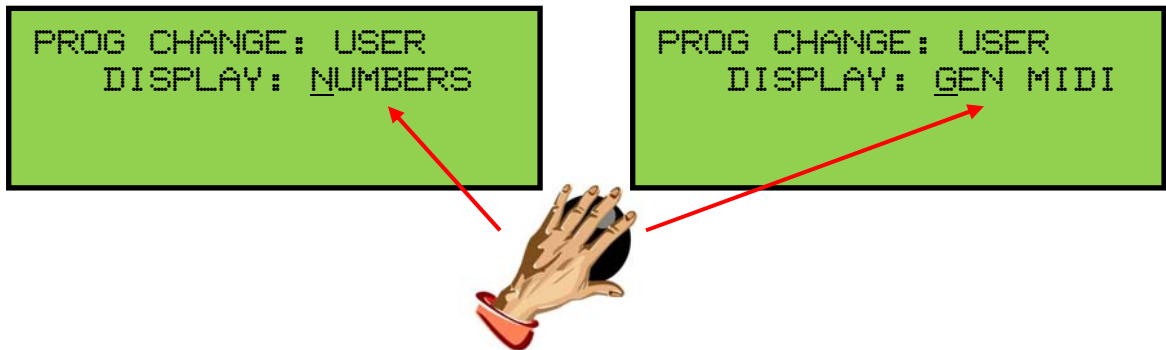

#### General MIDI Sound Names

With General MIDI mode selected, the 'PROG CHANGE' window will display:



Advance to the next window function then press a piston to view the sound names for any General MIDI device. The next window will display:



When a General piston is pressed, the GeniSys™ Controller™ will display the General MIDI sound name which corresponds to the MIDI program change selected. For example, press General Piston 1. The GeniSys™ Controller™ will display the MIDI program change name assigned to that piston.



**Note:** In some cases, the General MIDI sound name may be abbreviated.

You can change either the Bank value or Program Change name at any time by positioning the cursor on the value you wish to change.



```
GEN 1 BANK: _ 0  
P:Ac Grand Piano
```

```
GEN 1 BANK: 0  
P:Ac Grand Piano
```



Then, turn the **CHANGE** control knob to change the selected value. *Section D-4* explains this procedure in more detail.

1. Any Bank value between 0 and 127 may be selected.
2. Any General MIDI sound name may be selected and assigned to a piston. See *Section D-4* later in this manual for a list of available General MIDI sound names.

### Program Numbers:

With NUMBERS selected as the display mode, the 'MIDI PROGRAM CHANGE' window function will display:

```
GEN 1 BANK: ---  
P:
```

With PRESET selected as the program change mode, press a General piston. The GeniSys™ Controller will display the same MIDI program change number as the associated piston pressed. For example, pressing General Piston 1 will display:

```
GEN 1 BANK: ---  
P: 1
```



**Important!** The MIDI program change number will be displayed in PRESET mode, no matter if NUMBERS or GEN MIDI is selected. USER mode must be selected to view the GENERAL MIDI sound names. USER mode must also be selected to be able to assign MIDI program change numbers higher than the highest number of General pistons.

With USER selected as the program change mode, along with NUMBERS as the display mode, “- - -” (OFF) or any program change number from 1 through 128 may be assigned to any General piston.

There may be a number or “- -” following the “P:”. This “P:” represents the Program Change Number and does not stand for PRESET in this window. If there is “- -” following “P:” this means that the “ZERO” Program Change Number will be sent from the associated piston.

To change the MIDI program change numbers, press the **MOVE** button to position the cursor on the program change number value.



Turn the **CHANGE** control knob to change the program number value. *Section D-4* explains this procedure in more detail.

**Note:** The Allen Organ uses MIDI Program Change Zero as a message for "MIDI OFF."

**Important!** MIDI Program Change 1 corresponds to the General MIDI sound "Acoustic Grand Piano." Some MIDI devices do not use MIDI Program Change Zero as MIDI OFF. Consequently, Program Change Zero, (“- -” *in the display*) when sent from the organ, will correspond to Program Change 1 on those MIDI devices, MIDI Program Change 1 will correspond to MIDI Program Change 2, etc. You must understand how the connected MIDI device responds to MIDI program changes to know which program change numbers to assign to a General piston to be able to get a selected voice on a given MIDI device. Refer to the specific MIDI device’s owner’s manual for more information about MIDI program change response.

#### 4. Assigning MIDI Program Changes to Organ Pistons

This function allows the organist to select any voice on an external MIDI device by pressing any General piston on the organ. The "USER" program change mode must be selected (*See Section D-2*). Advance to the 'MIDI PROGRAM CHANGE' window function (*see Section A-2*).



For this example press the General Piston 2. The display will change to:



The LCD will display the piston pressed and the MIDI program number being transmitted by that piston.



To change the value transmitted, press the **MOVE** button to position the cursor on the program change number value. Turn the **CHANGE** control knob to change the program number value. Any program number of (1-128) may be selected (*see Section D-1*).



**Note:** Once a MIDI program change number is assigned to a piston, that program number will remain assigned to that piston even if the organ has been turned off.



**Important!** Once MIDI program change programming is complete the organist must exit the piston programming window function, by using the **SET** and **CANCEL** pistons (*see Section A-2*), for any changes to take effect.

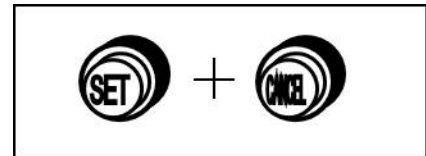

## 5. MIDI Bank Selecting

Many MIDI devices permit access to a variety of sounds in addition to the General MIDI sounds. Normally these additional sounds are stored in groups called **BANKS**. A **BANK** in MIDI terminology means a group of voices or sounds. There are two levels of banks. One level offers two choices, High Bank and Low Bank. Each of these, High Bank and Low Bank, has as sub-groups other level of banks, **BANK Numbers**.

MIDI devices can have as many as 128 sounds/voices per **BANK Number**. There can also be 128 available **BANK Numbers** (Ø through 127). With 128 **BANK Numbers**, each could contain up to 128 voices/sounds, for a total of 16,384 sounds. For an easier explanation, think of these **BANK Numbers** as floors or stories in a tall building. Each floor would contain 128 rooms and each room could then contain 128 voices.

There are MIDI devices that are High Bank and Low Bank compatible. It would be possible for these MIDI devices to have as many as (128 X 128 X 2 = 32,768 voices/sounds) 128 voices/sounds in each of the 128 **BANK Numbers**, in each of the High and Low Banks. Most MIDI devices do not use all of the locations available. It would be very expensive as well as difficult to remember the address for each sound location. There are also MIDI devices that offer only General MIDI sounds/voices. These General MIDI devices may operate using High Bank or Low Bank, but only the sub-group Ø **Bank Number** is used to store the 128 General MIDI sound settings. Allen Organs are able to access any of the Banks and therefore can communicate with all MIDI devices.

**Note:** You MUST know the capabilities of, and understand how to operate, the MIDI device you intend to use with the organ!

### Selecting High Bank or Low Bank:

Advance to the 'MIDI BASE CHANNEL' window function (*see Section A-2*).

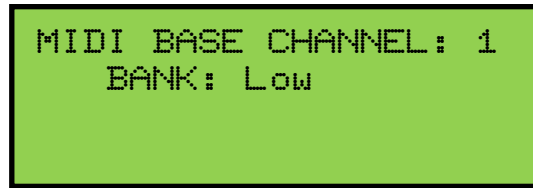

Press the **MOVE** button until the cursor is positioned on the BANK value.



Turn the **CHANGE** control knob to select either HIGH or LOW Bank priority.

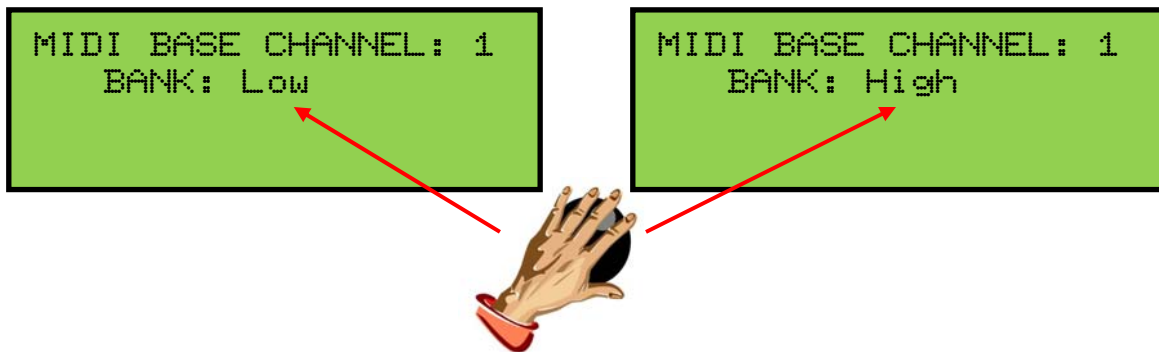

### Selecting MIDI Bank Numbers:

Bank Numbers are assignable in the same way that MIDI Program Numbers are (*See Section D-3*). You **MUST** have USER mode selected before assigning Bank numbers! Advance to the 'MIDI PROGRAM CHANGE' window function (*see Section A-2*).



For this example press the General piston #1. The display will change to:



The window will display the piston pressed, the MIDI BANK Number, and the program number being sent by that piston.



Press the **MOVE** button to position the cursor on the MIDI Bank number value. Turn the **CHANGE** control knob to change the MIDI BANK number value.

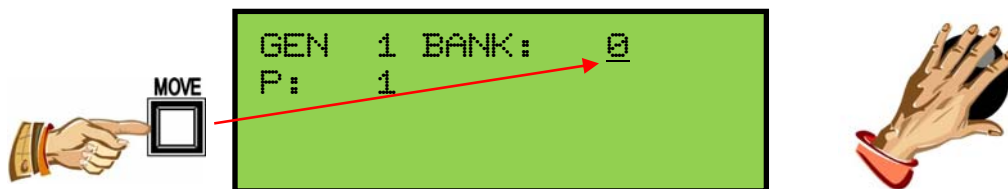

**Note:** Refer to the Bank selection/program number chart in the owner's manual for the external MIDI device you are using to be sure you are using a valid Bank number value.

**Note:** Once you have assigned a MIDI BANK Number to a piston, that number will remain assigned to that piston even if the organ has been turned off.



**Important!** Once MIDI Bank change programming is complete the user must exit the piston programming window function, by using the **SET** and **CANCEL** pistons (*see Section A-2*), for any changes to take effect.



## 6. Changing the MIDI Base Channel

This function allows the organist to change the setting of the MIDI Base Channel. The Base Channel is a reference point to establish the positioning of the other 15 MIDI channels on the organ. On Allen Organs, the Base Channel equals the Swell Division's channel of transmission (i.e., if the Base Channel = 1, then the Swell Channel = 1, if the Base Channel = 2, then the Swell Channel = 2, etc.). Moving the Base Channel allows you to shift the organ's range of MIDI channels, this is helpful when reassigning an external MIDI device from one organ division to another.



**Important!** The Base Channel always resets to MIDI Channel 1 whenever the organ is turned on.

Advance to the 'MIDI BASE CH' window function (*see Section A-2*).

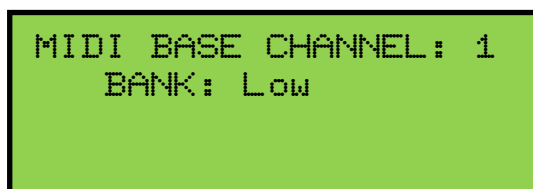

Press the **MOVE** button to position the cursor on the MIDI Base Channel value. Turn the **CHANGE** control knob to change the value. All functions associated with a particular division will transmit and receive on its assigned channel. For example, MIDI Channel 1 is normally assigned to the Swell Division and the Swell Manual. Therefore, keying velocity or on/off messages will be transmitted and received on MIDI Channel 1 (*See Section D-1 for Allen MIDI Channel Assignments*).

If the Base Channel is set to 2, all of the channels will shift higher by one. Now; Swell = 2, Great = 3, Pedal = 4 and the General Pistons = 9.

**Note:** MIDI Channel numbers will wrap, i.e. as MIDI channel numbers only go to 16 and then repeat to 1.

## 7. MIDI Expression Settings

Advance to the 'MIDI EXPRESSION' window function (*see Section A-2*).



There are four modes for transmitting expression data via MIDI. To select an expression mode, press the **MOVE** button to position the cursor on the expression setting value (line 2) of the display.

Turn the **CHANGE** control knob to select one of the four different expression modes.

**Note:** The default expression mode setting is always POLY-VOLUME.

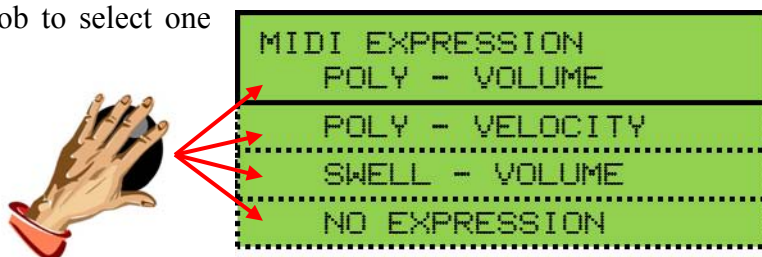

### MIDI Expression Modes:

**POLY-VOLUME** — this is the normal expression mode setting where the expression data is distributed among the appropriate MIDI channels.

**POLY-VELOCITY** — this setting should be selected if you are using a percussion-type voice from a sound module or an external MIDI keyboard. For example, if a digital piano sound were played from the organ keyboard through MIDI Channel 1, the piano could be made to sound more realistic. By opening the Swell expression shoe, the piano strings would appear to be struck harder than when the Swell pedal was in the closed position.



**Important!** This mode setting should only be used if the organ does not contain velocity sensitive keying.

**Note:** In POLY-VELOCITY mode, all expression information is sent in key velocity form. Changes in velocity will occur only when a new key is struck. Consequently, if you change the position of the expression pedal after a key is struck there will be no change in velocity until a new key is struck. Use this mode only when a velocity-sensitive external MIDI device is connected. If this mode is selected when recording to a sequencer, the expression on the organ will not function when playing back from the sequencer.

**SWELL-VOLUME** — this mode setting causes MIDI expression data to be sent only on the Swell MIDI channel. Some early sequencers can only interpret one volume message.

**NO EXPRESSION** — No MIDI expression (volume) data sent.

## 8. MIDI Sustain Kick Switch (optional)

A lever located to the left of the expression shoe and controlled by the organist's foot, operates MIDI sustain. This function can be assigned to any one of or all of the instrument's manuals. Advance to the 'MIDI SUSTAIN' window function (*see Section A-2*).

```
MIDI SUSTAIN
Sw = ON
```

To select an organ keyboard (manual), press the **MOVE** button to position the cursor on the manual abbreviation.



Turn the **CHANGE** control knob to select an organ keyboard.



```
MIDI SUSTAIN
Sw = ON
```

To turn the MIDI Sustain function on/off on the selected manual, press the **MOVE** button to position the cursor on the MIDI Sustain value.



```
MIDI SUSTAIN
Sw = ON
```

Turn the **CHANGE** control knob to turn the selected manual on/off.

**OFF** will not allow MIDI Sustain messages to be transmitted, **ON** will allow MIDI sustain messages to be transmitted on a given keyboard (manual) or MIDI channel. For example, when a **PIANO** voice in an external MIDI device (voice module) is selected and the MIDI sustain for that given MIDI channel (division) is turned **ON**, and the foot controlled sustain lever is actuated, the piano sound will slowly decay.

## 9. Organ Local Off

Organ Local Off is a function that allows the user to “virtually” disconnect the organ's keyboards, pedalboard and pistons from the organ's tone generation and capture system. In essence, the organ is transformed into a sophisticated multi-manual MIDI controller.

To enable/disable the Organ Local Off function, advance to the 'ORGAN LOCAL OFF' window function (*see Section A-2*).

```
ORGAN LOCAL OFF
= DISABLED
```

To enable/disable the Organ Local Off function, press the **MOVE** button to position the cursor on the Local Off control value.

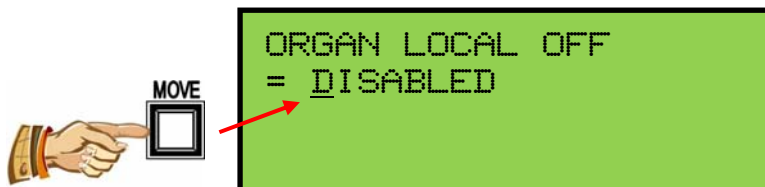

Turn the **CHANGE** control knob to change the enable/disable value.

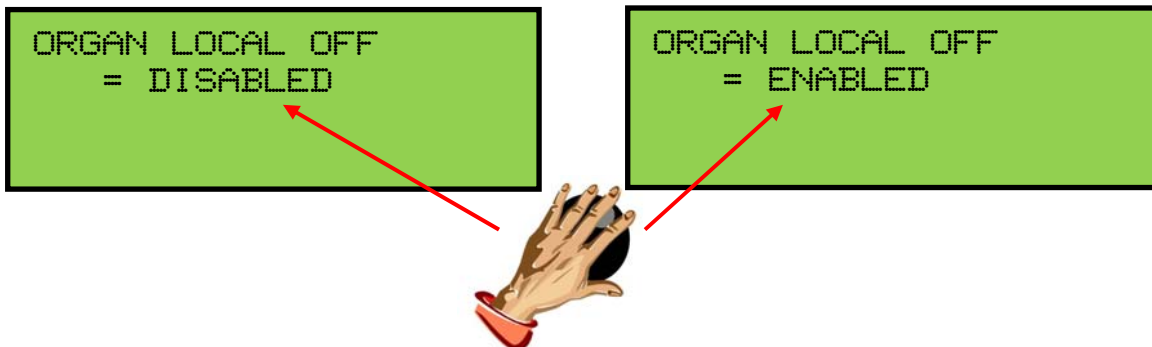

**Note:** When Organ Local Off is enabled, the MIDI stops do not need to be on to play the external MIDI device(s).

## 10. Transmission/Reception of Individual Stop Data

This function allows the organist to turn on/off the transmission and reception of individual stop data, known in MIDI terminology as "Non-Registered Parameters". In some cases individual stop data (on/off) from the organ may conflict with data from an external MIDI device. When this occurs, select the "OFF" position.

**Note:** Piston changes will still be transmitted and received, because they are classified as MIDI program changes.

Advance to the 'TRANSMIT / RECEIVE STOPS' window function:



To change the on/off status of the Transmit/Receive Stops function, press the **MOVE** button to position the cursor on the control value.

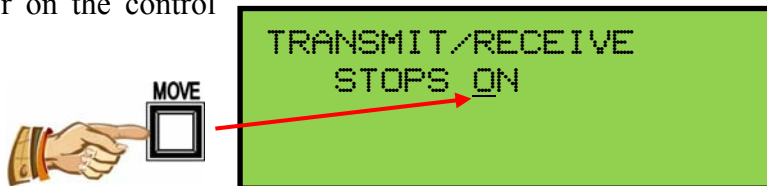

Turn the **CHANGE** control knob to change the transmit/receive status on or off.



## **E. MIDI GUIDE**

### **1. MIDI for Organists**

The term MIDI is an acronym for Musical Instrument Digital Interface. Since 1983, MIDI has been adopted by the music industry as a standard means of communication between digital musical devices enabling instruments of different types and manufacturers to communicate. MIDI by itself will not make a sound. It is not necessary to understand all of the technical aspects of MIDI in order to take advantage of the benefits it offers. It is important to explore the potential MIDI holds for musicians, as well as the various MIDI applications available today.

#### **Types of MIDI Devices**

MIDI devices fall into two categories.

1. The first category consists of musical instruments such as organs and synthesizers that transmit and receive MIDI data.
2. The second category includes controllers and processors that, as their name implies, can transmit, receive or manipulate MIDI data, but do not necessarily produce sound themselves. Sequencers, which are MIDI recording devices, fall into this category. Although the technical nature of their recording and editing processes differs from those of a tape recorder, many operate in similar fashion. Most are equipped with record, playback, fast forward and reverse controls that function in the same way as their tape recorder counterparts.

#### **Types of MIDI Data**

There are several types of MIDI messages that can be sent from one device to another. The most common is keying information, allowing one device to sense which keys have been played on another device. This means an organ equipped with MIDI can send information to other MIDI devices, e.g., synthesizers or sequencers, and can play those devices simultaneously or record information to be played back later.

Allen Organs incorporate an advanced MIDI system allowing the transmission and reception of all types of MIDI information (velocity keying, volume, sustain, registrations and much more). It is even possible to control several devices from one manual simultaneously, or control a different device from each manual of the console.

#### **MIDI as a Practice Tool**

For the organist/choir director, the MIDI organ console and sequencer are valuable rehearsal tools for both choral and organ works. Anthem accompaniments may be recorded in advance and played back by the sequencer during choir rehearsal. The director, freed from the role of accompanist, can focus entirely on directing the choir. The sequencer can play the music back at a slower tempo without affecting pitch or at a lower pitch without affecting tempo, features that are useful in rehearsing difficult choral passages.

If the sequencer allows multi-tracking, each vocal section's part may be recorded on a different track, and then played back individually, or in any combination, for more flexibility. Multi-tracking can also be used in teaching and learning new organ works. The teacher may record each hand or pedal part on a different track, allowing the student to "mute" or turn off any part being practiced while still being able to hear the sequencer play the rest of the composition. The student's ability to hear the piece in its entirety from the earliest stage of learning a composition, and to become aware of the interrelationship of its voices, is especially valuable in learning contrapuntal works.

### **MIDI as a Registration Tool**

In some churches and auditoriums it is difficult to judge the effectiveness of a registration from the organ console. Due to the acoustics of the room, or positioning of the console, the sound of the instrument may be different when listened to from the congregation's or audience's vantage point. MIDI allows the organist to evaluate registrations by recording the music using a sequencer, and then listening from different locations in the room during the music's playback.

### **Other MIDI Uses**

MIDI has created new possibilities for the organist. The ability of the organ console to control external keyboards or sound modules puts an ever-increasing array of non-traditional sounds at the organist's fingertips. A superior degree of control is made possible by the flexibility of an organ console. The ability to record MIDI data using a sequencer opens a variety of new possibilities during practice and performance situations.

Computer software programs are also available that allow musicians to play MIDI devices connected to a computer, and have their performance printed as conventional five-line musical notation. Because MIDI is an industry-wide standard, today's MIDI instruments will be compatible with tomorrow's MIDI innovations.

## **2. Allen's Exclusive MIDI System**

Allen Organs feature an advanced MIDI system with increased flexibility. This system provides a comprehensive interface between MIDI sound modules, such as the Allen Ensemble™, and digital sequencers such as the Allen MIDI Assistant™. Two MIDI Out ports, one switched and one unswitched, allow unprecedented control over external MIDI devices attached to the organ.

Under normal circumstances, MIDI sound modules should be connected to the switched MIDI port, labeled MIDI OUT 2. Doing so allows the organist to disable the sending of MIDI keying data from the organ to the sound module. Devices such as MIDI sequencers should be connected to the unswitched MIDI port, labeled MIDI OUT 1, eliminating the necessity of having to draw the MIDI stop controls before recording a digital sequence. The drawing below illustrates the proper procedure for connecting the Allen Ensemble™ and Allen MIDI Assistant™ to an Allen Organ.

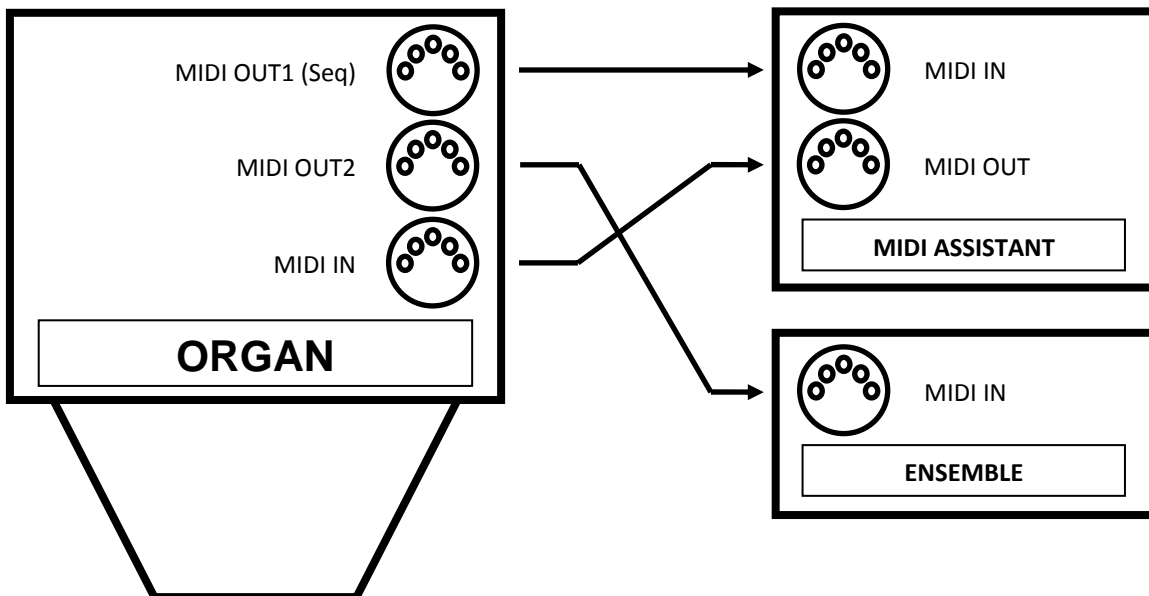

### 3. MIDI Transmission Channels

MIDI information may be transmitted on several different channels simultaneously. This allows many channels of information to be sent through one cable and used independently from one another, similar to the way many television broadcasts can be sent through one cable. In order to receive the intended information, a MIDI device must be tuned to the same channel as the device that is sending the information.

Your Allen Organ transmits MIDI information on several channels. When external MIDI devices are connected to the organ, it is important to make sure that the devices' channels of transmission and reception match the MIDI channels of the Allen Organ divisions to which they are assigned.

MIDI Program Change Messages are transmitted from the organ's General Pistons on MIDI Channel 8. These program change messages can be used to change the settings of MIDI sound modules or synthesizers that are connected to the organ. Please consult the owner's manual of your MIDI device(s) for more information on how MIDI Program Change Messages are handled by that particular device.

In addition to keying and divisional registration information, MIDI Volume Messages are sent on the individual MIDI channels for each division of the organ. These volume messages are controlled by the expression shoe. In this manner, the volume of connected MIDI devices may be controlled.

Please consult the owner's manual of your MIDI device(s) for more information on how MIDI Volume information is handled by that device. If any external MIDI device is used to transmit information to the Allen organ, the same assignment of MIDI channels must be used as described elsewhere in this manual.

#### 4. GENERAL MIDI SOUND SET

- |                             |                            |                           |
|-----------------------------|----------------------------|---------------------------|
| 1. Acoustic Grand Piano     | 44. Contrabass             | 86. Lead 6 (voice)        |
| 2. Bright Acoustic Piano    | 44. Contrabass             | 86. Lead 6 (voice)        |
| 3. Electric Grand Piano     | 45. Tremolo Strings        | 87. Lead 7 (fifths)       |
| 4. Honky-tonk Piano         | 46. Pizzicato Strings      | 88. Lead 8 (brass + lead) |
| 5. Rhodes Piano             | 47. Orchestral Harp        | 89. Pad 1 (new age)       |
| 6. Chorused Piano           | 48. Timpani                | 90. Pad 2 (warm)          |
| 7. Harpsichord              | 49. String Ensemble 1      | 91. Pad 3 (polysynth)     |
| 8. Clavinet                 | 50. String Ensemble 2      | 92. Pad 4 (choir)         |
| 9. Celesta                  | 51. Synth Strings 1        | 93. Pad 5 (bowed)         |
| 10. Glockenspiel            | 52. Synth Strings 2        | 94. Pad 6 (metallic)      |
| 11. Music Box               | 53. Choir Aahs             | 95. Pad 7 (halo)          |
| 12. Vibraphone              | 54. Voice Oohs             | 96. Pad 8 (sweep)         |
| 13. Marimba                 | 55. Synth Voice            | 97. FX 1 (rain)           |
| 14. Xylophone               | 56. Orchestra Hit          | 98. FX 2 (soundtrack)     |
| 15. Tubular Bells           | 57. Trumpet                | 99. FX 3 (crystal)        |
| 16. Dulcimer                | 58. Trombone               | 100. FX 4 (atmosphere)    |
| 17. Hammond Organ           | 59. Tuba                   | 101. FX 5 (brightness)    |
| 18. Percussive Organ        | 60. Muted Trumpet          | 102. FX 6 (goblins)       |
| 19. Rock Organ              | 61. French Horn            | 103. FX 7 (echoes)        |
| 20. Church Organ            | 62. Brass Section          | 104. FX 8 (sci-fi)        |
| 21. Reed Organ              | 63. Synth Brass 1          | 105. Sitar                |
| 22. Accordion               | 64. Synth Brass 2          | 106. Banjo                |
| 23. Harmonica               | 65. Soprano Sax            | 107. Shamisen             |
| 24. Tango Accordion         | 66. Alto Sax               | 108. Koto                 |
| 25. Acoustic Guitar (nylon) | 67. Tenor Sax              | 109. Kalimba              |
| 26. Acoustic Guitar (steel) | 68. Baritone Sax           | 110. Bagpipe              |
| 27. Electric Guitar (jazz)  | 69. Oboe                   | 111. Fiddle               |
| 28. Electric Guitar (clean) | 70. English Horn           | 112. Shanai               |
| 29. Electric Guitar (muted) | 71. Bassoon                | 113. Tinkle Bell          |
| 30. Overdriven Guitar       | 72. Clarinet               | 114. Agogo                |
| 31. Distortion Guitar       | 73. Piccolo                | 115. Steel Drums          |
| 32. Guitar Harmonics        | 74. Flute                  | 116. Woodblock            |
| 33. Acoustic Bass           | 75. Recorder               | 117. Taiko Drum           |
| 34. Electric Bass (finger)  | 76. Pan Flute              | 118. Melodic Tom          |
| 35. Electric Bass (pick)    | 77. Bottle Blow            | 119. Synth Drum           |
| 36. Fretless Bass           | 78. Shakuhachi             | 120. Reverse Cymbal       |
| 37. Slap Bass 1             | 79. Whistle                | 121. Guitar Fret Noise    |
| 38. Slap Bass 2             | 80. Ocarina                | 122. Breath Noise         |
| 39. Synth Bass 1            | 81. Lead 1 (square)        | 123. Seashore             |
| 40. Synth Bass 2            | 82. Lead 2 (sawtooth)      | 124. Bird Tweet           |
| 41. Violin                  | 83. Lead 3 (calliope lead) | 125. Telephone Ring       |
| 42. Viola                   | 84. Lead 4 (chiff lead)    | 126. Helicopter           |
| 43. Cello                   | 85. Lead 5 (charang)       | 127. Applause             |
|                             |                            | 128. Gunshot              |



## APPENDIX A: MIDI IMPLEMENTATION CHART

FUNCTION		TRANSMITTED	RECEIVED
Basic Channel	Default	1 – 16	1 – 16
	Changed	1 – 16	1 – 16
Mode	Default	3	3
	Messages	X	X
	Altered	X	X
Note Number		O (1 – 127)	O (1 – 127)
Velocity	Note ON Note OFF	9nH, v = 1 – 127 9nH, v = 0	9nH, v = 1 – 127 9nH, v = 0
Aftersustain	Keys	X	X
	Channels	X	X
Pitch Bend		O	O
Control Change	0 (bank select)	O	X
	6 (Data MSB)	O	O
	7 (volume)	O	O
	64 (sustain)	O	O
	66 (sostenuto)	O	O
	98 (NRPN: LSB) 99 (NRPN: MSB)	O O	O O
Program Change		O (1 – 127)	O (1 – 127)
System Exclusive		O	O
System Common		X	X
System Real Time		X	X
Aux Messages		X	X

Mode 1: Omni On, Poly  
Mode 3: Omni Off, Poly

Mode 2: Omni On, Mono  
Mode 4: Omni Off, Mono

O: Yes  
X: No

## **APPENDIX B: GNU PUBLIC LICENSE INFORMATION**

### **NOTICE:**

Portions (but not all) of the software contained within this device are covered by the GNU General Public License shown below. As Such, for a period of three years after the manufacture date, you are entitled to a machine-readable copy of the applicable source code for a fee that covers the distribution costs. You may request a copy by sending that request in writing to:

GENISYS GPL REQUEST  
ALLEN ORGAN COMPANY LLC  
150 LOCUST ST.  
MACUNGIE, PA 18062

Please include your name, address, and phone number.

All portions not covered by the GNU GPL are to be considered Copyright (C) 2008, Allen Organ Company LLC, all rights reserved.

GNU GENERAL PUBLIC LICENSE  
Version 2, June 1991  
Copyright (C) 1989, 1991 Free Software Foundation, Inc.  
51 Franklin St, Fifth Floor, Boston, MA 02110-1301 USA

Everyone is permitted to copy and distribute verbatim copies of this license document, but changing it is not allowed.

### **PREAMBLE**

The licenses for most software are designed to take away your freedom to share and change it. By contrast, the GNU General Public License is intended to guarantee your freedom to share and change free software--to make sure the software is free for all its users. This General Public License applies to most of the Free Software Foundation's software and to any other program whose authors commit to using it. (Some other Free Software Foundation software is covered by the GNU Library General Public License instead.) You can apply it to your programs, too. When we speak of free software, we are referring to freedom, not price. Our General Public Licenses are designed to make sure that you have the freedom to distribute copies of free software (and charge for this service if you wish), that you receive source code or can get it if you want it, that you can change the software or use pieces of it in new free programs; and that you know you can do these things. To protect your rights, we need to make restrictions that forbid anyone to deny you these rights or to ask you to surrender the rights. These restrictions translate to certain responsibilities for you if you distribute copies of the software, or if you modify it. For example, if you distribute copies of such a program, whether gratis or for a fee, you must give the recipients all the rights that you have. You must make sure that they, too, receive or can get the source code. And you must show them these terms so they know their rights. We protect your rights with two steps: (1) copyright the software, and (2) offer you this license which gives you legal permission to copy, distribute and/or modify the software. Also, for each author's protection and ours, we want to make certain that everyone understands that there is no warranty for this free software. If the software is modified by someone else and passed on, we want its recipients to know that what they have is not the original, so that any problems introduced by others will not reflect on the original authors' reputations. Finally, any free program is threatened constantly by software patents. We wish to avoid the danger that redistributors of a free program will individually obtain patent licenses, in effect making the program proprietary. To prevent this, we have made it clear that any patent must be licensed for everyone's free use or not licensed at all. The precise terms and conditions for copying, distribution and modification follow.

## GNU GENERAL PUBLIC LICENSE

### TERMS AND CONDITIONS FOR COPYING, DISTRIBUTION AND MODIFICATION

1. This License applies to any program or other work which contains a notice placed by the copyright holder saying it may be distributed under the terms of this General Public License. The "Program", below, refers to any such program or work, and a "work based on the Program" means either the Program or any derivative work under copyright law: that is to say, a work containing the Program or a portion of it, either verbatim or with modifications and/or translated into another language. (Hereinafter, translation is included without limitation in the term "modification".) Each licensee is addressed as "you". Activities other than copying, distribution and modification are not covered by this License; they are outside its scope. The act of running the Program is not restricted, and the output from the Program is covered only if its contents constitute a work based on the Program (independent of having been made by running the Program). Whether that is true depends on what the Program does.
2. You may copy and distribute verbatim copies of the Program's source code as you receive it, in any medium, provided that you conspicuously and appropriately publish on each copy an appropriate copyright notice and disclaimer of warranty; keep intact all the notices that refer to this License and to the absence of any warranty; and give any other recipients of the Program a copy of this License along with the Program. You may charge a fee for the physical act of transferring a copy, and you may at your option offer warranty protection in exchange for a fee.
3. You may modify your copy or copies of the Program or any portion of it, thus forming a work based on the Program, and copy and distribute such modifications or work under the terms of Section 1 above, provided that you also meet all of these conditions:
  - a. You must cause the modified files to carry prominent notices stating that you changed the files and the date of any change.
  - b. You must cause any work that you distribute or publish, that in whole or in part contains or is derived from the Program or any part thereof, to be licensed as a whole at no charge to all third parties under the terms of this License.
  - c. If the modified program normally reads commands interactively when run, you must cause it, when started running for such interactive use in the most ordinary way, to print or display an announcement including an appropriate copyright notice and a notice that there is no warranty (or else, saying that you provide a warranty) and that users may redistribute the program under these conditions, and telling the user how to view a copy of this License. (Exception: if the Program itself is interactive but does not normally print such an announcement, your work based on the Program is not required to print an announcement.) These requirements apply to the modified work as a whole. If identifiable sections of that work are not derived from the Program, and can be reasonably considered independent and separate works in themselves, then this License, and its terms, do not apply to those sections when you distribute them as separate works. But when you distribute the same sections as part of a whole which is a work based on the Program, the distribution of the whole must be on the terms of this License, whose permissions for other licensees extend to the entire whole, and thus to each and every part regardless of who wrote it. Thus, it is not the intent of this section to claim rights or contest your rights to work written entirely by you; rather, the intent is to exercise the right to control the distribution of derivative or collective works based on the Program. In addition, mere aggregation of another work not based on the Program with the Program (or with a work based on the Program) on a volume of a storage or distribution medium does not bring the other work under the scope of this License.
4. You may copy and distribute the Program (or a work based on it, under Section 2) in object code or executable form under the terms of Sections 1 and 2 above provided that you also do one of the following:
  - a. Accompany it with the complete corresponding machine-readable source code, which must be distributed under the terms of Sections 1 and 2 above on a medium customarily used for software interchange; or,
  - b. Accompany it with a written offer, valid for at least three years, to give any third party, for a charge no more than your cost of physically performing source distribution, a complete machine-readable copy of the corresponding source code, to be distributed under the terms of Sections 1 and 2 above on a medium customarily used for software interchange; or,

- c. Accompany it with the information you received as to the offer to distribute corresponding source code. (This alternative is allowed only for noncommercial distribution and only if you received the program in object code or executable form with such an offer, in accord with Subsection b above.) The source code for a work means the preferred form of the work for making modifications to it. For an executable work, complete source code means all the source code for all modules it contains, plus any associated interface definition files, plus the scripts used to control compilation and installation of the executable. However, as a special exception, the source code distributed need not include anything that is normally distributed (in either source or binary form) with the major components (compiler, kernel, and so on) of the operating system on which the executable runs, unless that component itself accompanies the executable. If distribution of executable or object code is made by offering access to copy from a designated place, then offering equivalent access to copy the source code from the same place counts as distribution of the source code, even though third parties are not compelled to copy the source along with the object code.
5. You may not copy, modify, sublicense, or distribute the Program except as expressly provided under this License. Any attempt otherwise to copy, modify, sublicense or distribute the Program is void, and will automatically terminate your rights under this License. However, parties who have received copies, or rights, from you under this License will not have their licenses terminated so long as such parties remain in full compliance.
6. You are not required to accept this License, since you have not signed it. However, nothing else grants you permission to modify or distribute the Program or its derivative works. These actions are prohibited by law if you do not accept this License. Therefore, by modifying or distributing the Program (or any work based on the Program), you indicate your acceptance of this License to do so, and all its terms and conditions for copying, distributing or modifying the Program or works based on it.
7. Each time you redistribute the Program (or any work based on the Program), the recipient automatically receives a license from the original licensor to copy, distribute or modify the Program subject to these terms and conditions. You may not impose any further restrictions on the recipients' exercise of the rights granted herein. You are not responsible for enforcing compliance by third parties to this License.
8. If, as a consequence of a court judgment or allegation of patent infringement or for any other reason (not limited to patent issues), conditions are imposed on you (whether by court order, agreement or otherwise) that contradict the conditions of this License, they do not excuse you from the conditions of this License. If you cannot distribute so as to satisfy simultaneously your obligations under this License and any other pertinent obligations, then as a consequence you may not distribute the Program at all. For example, if a patent license would not permit royalty-free redistribution of the Program by all those who receive copies directly or indirectly through you, then the only way you could satisfy both it and this License would be to refrain entirely from distribution of the Program. If any portion of this section is held invalid or unenforceable under any particular circumstance, the balance of the section is intended to apply and the section as a whole is intended to apply in other circumstances. It is not the purpose of this section to induce you to infringe any patents or other property right claims or to contest validity of any such claims; this section has the sole purpose of protecting the integrity of the free software distribution system, which is implemented by public license practices. Many people have made generous contributions to the wide range of software distributed through that system in reliance on consistent application of that system; it is up to the author/donor to decide if he or she is willing to distribute software through any other system and a licensee cannot impose that choice. This section is intended to make thoroughly clear what is believed to be a consequence of the rest of this License.
9. If the distribution and/or use of the Program is restricted in certain countries either by patents or by copyrighted interfaces, the original copyright holder who places the Program under this License may add an explicit geographical distribution limitation excluding those countries, so that distribution is permitted only in or among countries not thus excluded. In such case, this License incorporates the limitation as if written in the body of this License.
10. The Free Software Foundation may publish revised and/or new versions of the General Public License from time to time. Such new versions will be similar in spirit to the present version, but may differ in detail to address new problems or concerns. Each version is given a distinguishing version number. If the Program specifies a version number of this License which applies to it and "any later version", you have the option of following the terms and conditions either of that version or of any later version published by the Free Software Foundation. If the Program does not specify a version number of this License, you may choose any version ever published by the Free Software Foundation.

11. If you wish to incorporate parts of the Program into other free programs whose distribution conditions are different, write to the author to ask for permission. For software which is copyrighted by the Free Software Foundation, write to the Free Software Foundation; we sometimes make exceptions for this. Our decision will be guided by the two goals of preserving the free status of all derivatives of our free software and of promoting the sharing and reuse of software generally.

**NO WARRANTY**

12. Because the program is licensed free of charge, there is no warranty for the program, to the extent permitted by applicable law. Except when otherwise stated in writing the copyright holders and/or other parties provide the program "as is" without warranty of any kind, either expressed or implied, including, but not limited to, the implied warranties of merchantability and fitness for a particular purpose. The entire risk as to the quality and performance of the program is with you. Should the program prove defective, you assume the cost of all necessary servicing, repair or correction.
13. In no event unless required by applicable law or agreed to in writing will any copyright holder, or any other party who may modify and/or redistribute the program as permitted above, be liable to you for damages, including any general, special, incidental or consequential damages arising out of the use or inability to use the program (including but not limited to loss of data or data being rendered inaccurate or losses sustained by you or third parties or a failure of the program to operate with any other programs), even if such holder or other party has been advised of the possibility of such damages.

End of terms and conditions