

MDS-1

Copyright © 1992 Allen Organ Company
All Rights Reserved

AOC P/N 033-0050



All warning and safety instructions pertain to the organ and the amp rack (if required).

Explanation of Graphical Symbols:

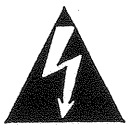

The lightning flash with arrowhead symbol within an equilateral triangle is intended to alert the user to the presence of uninsulated "dangerous voltage" within the instrument's enclosure that may be of sufficient magnitude to constitute a risk of electrical shock to persons.



The exclamation point within an equilateral triangle is intended to alert the user to the presence of important operating and maintenance (servicing) instructions in the literature accompanying the instrument.

Warning: To reduce the risk of fire or electrical shock, do not expose this instrument to rain or moisture. Do not plug the instrument into any current source other than 105-128 volts, 50/60 Hertz alternating current (AC). A certified grounded outlet is essential to proper operation and protection of the instrument. Proper polarity should be checked with an AC circuit analyzer before connecting the instrument.

To reduce the risk of electrical shock, match the wide blade of the instrument AC cord power plug to the wide slot in the receptacle and fully insert the plug into the receptacle.

Do not change the cable plug or remove the ground pin or connect with a two-pole adapter.

If you are in doubt about your electrical connection, consult your local electrician or power company.

For safety reasons, make sure any equipment or accessories connected to this instrument bear the UL listing symbol.

Read and comply with all instructions and labels that may be attached to the instrument.

In churches where circuit breakers are turned off between worship services, the circuit breaker affecting the organ console AC power should have a guard installed to prevent its being accidentally switched off.

IMPORTANT SAFETY INSTRUCTIONS

These safety instructions are provided to reduce the risk of fire, electric shock and injury. **WARNING** -- When using electric products, basic precautions should always be followed, including the following:

1. Read and understand all instructions and warnings.
2. This product may be equipped with a polarized line plug (one blade wider than other). This is a safety feature. If you are unable to insert plug into outlet, contact an electrician to replace obsolete outlet. Do not defeat the safety purpose of the plug.
3. Do not overload wall outlets and extension cords. This can increase the risk of fire or electric shock.
4. Do not allow anything to rest on the power cord.
5. Care should be taken so that objects do not fall and liquids are not spilled into the enclosure through openings.
6. Unplug the organ from the wall outlet and consult qualified service personnel in any of the following situations.
 - The power supply cord is frayed or damaged.
 - Liquid has been spilled into the product.
 - The product has been exposed to water.
 - The product does not appear to operate normally or exhibits a marked change in performance.
 - The product has been dropped, or the enclosure damaged.
7. This product, either alone or in combination with an amplifier and headphones or speakers, may be capable of producing sound levels that could cause permanent hearing loss. Do not operate for a long period of time at a high volume level or at a level that is uncomfortable. If you experience any hearing loss or ringing in the ears, you should consult an audiologist.
8. Do not attempt to service the product beyond that described in the owners manual. All other servicing should be referred to qualified service personnel.

Grounding instructions - This product must be grounded. If it should malfunction or break down, grounding provides a path of least resistance for electric current to reduce the risk of electric shock. This product is equipped with a cord having an equipment-grounding conductor and a grounding plug. The plug must be plugged into an appropriate outlet that is properly installed and grounded in accordance with all local codes and ordinances.

DANGER - Improper connection of the equipment-grounding conductor can result in a risk of electric shock. Check with a qualified electrician or serviceman if you are in doubt as to whether the product is properly grounded. Do not modify the plug provided with the product - if it will not fit the outlet, have a proper outlet installed by a qualified electrician.

SAVE THESE INSTRUCTIONS

ALL WARNING AND SAFETY INSTRUCTIONS PERTAIN
TO THE ORGAN AND THE AMP RACK (IF REQUIRED)

重要な安全上の注意

この安全上の注意書は火災・感電・傷害の危険を避けるためのものです。

警告—電気製品を使用する際は、以下の基本的な注意を常に守って下さい：

1. 取扱説明書と注意書きに全て目を通して下さい。
2. この製品には極性プラグ（一方の刃がもう一方よりも幅広いもの）が取り付けられています。これは安全を確保するためのものです。コンセントに電源プラグを差し込めない場合は、電気技術者に連絡をとり、旧型のコンセントを新しいものに取り替えて下さい。極性プラグの安全目的を妨げないようにして下さい。
3. コンセントと延長コードに負荷をかけ過ぎないで下さい。火災と感電の危険があります。
4. 電源コードの上には何も置かないで下さい。
5. 内部に、物を落としたり液体をこぼしたりしないよう、注意してください。
6. 次の場合にはコンセントからオルガンの電源コードを抜き、専門のサービスマンに相談して下さい。

- 電源コードがすり切れたり傷んでいる。
- 製品の中に液体をこぼした。
- 製品を水に濡らした。
- 製品が正常に動作しない、性能に著しい変化が見られる。
- 製品を落としてしまった、外装が破損した。

7. この製品は、単独でも、あるいはアンプやヘッドフォンやスピーカーと組み合わせることによって、慢性的な聴覚の原因となる程の音量を出すことが出来ます。大きなボリューム・レベルや、不快なレベルで、長時間使用しないで下さい。少しでも難聴や耳鳴りを感じたら、専門医に相談して下さい。
8. オーナーズ・マニュアルに書かれた内容以外に製品の修理をしようとししないで下さい。その他の調整・修理は専門のサービスマンにおまかせ下さい。

接地（アース）に関する指示—この製品は必ずアースを取らなくてはなりません。振動や故障が生じた際、アースしておくことで、抵抗が最小の電流経路が確保され、感電の危険を減らすことになります。この製品の電源コードにはアース線と接地プラグがついています。電源プラグは、関連法規に従って正しく取り付けられアース付きコンセントに差し込まなくてはなりません。

危険—アース線の取り方を誤ると、感電する危険があります。もし製品が正しくアースされているかどうか疑わしい時は、専門の電気技術者かサービスマンに点検を依頼して下さい。製品に付いている電源プラグを変更しないで下さい。もしコンセントに合わないような場合は、専門の電気技術者に正しいコンセントを取り付けてもらって下さい。

以上の指示をお守り下さい

CONSIGNES DE SECURITE IMPORTANTES

Les consignes de sécurité ci-dessous sont destinées à réduire les risques de feu, de court-circuit et de blessure.

ATTENTION : En utilisant des produits électriques, les précautions de base doivent toujours être prises, y compris les suivantes :

1. Lire et respecter toutes les instructions et les avertissements,
2. Ce produit est équipé d'une prise d'alimentation où les polarités sont repérées (les plots de connexion ne peuvent pas être inversés). Ceci est une mesure de sécurité. Si vous ne pouvez pas connecter la prise d'alimentation de l'instrument à votre prise murale, contactez un électricien pour la remise en conformité de votre prise. Ne supprimez jamais la terre de la prise d'alimentation.
3. Ne surchargez pas les prises murales et les rallonges. Ceci pourrait accroître les risques d'incendie ou de court-circuit.
4. Ne rien poser sur le câble d'alimentation.
5. Il convient de faire attention à ce que des objets et des liquides ne soient pas renversés dans la console par les ouvertures.
6. Débranchez l'orgue et consultez un technicien Allen dans tous les cas suivants :
 - le cordon d'alimentation est détérioré,
 - du liquide a été renversé dans l'instrument,
 - l'instrument a été exposé à l'eau,
 - l'orgue ne paraît pas fonctionner normalement ou montre des performances altérées.
 - l'instrument est tombé et la console est abîmée.
7. Cet instrument, seul ou en combinaison avec un amplificateur et un casque ou des haut-parleurs, est capable de produire des niveaux de sons qui pourraient causer une perte permanente d'audition. Ne travaillez pas pendant une longue durée à un volume élevé ou à un volume inapproprié. Si vous constatez une perte auditive ou des bourdonnements, consultez un spécialiste.
8. Ne pas intervenir dans l'appareil au-delà de ce qui est indiqué dans le manuel de l'utilisateur. Toutes les autres interventions doivent être confiées à un technicien Allen.

Instructions de base :

L'instrument doit être équipé d'une prise de terre. Dans le cas d'un dysfonctionnement ou d'une panne, la mise à la terre fournit un chemin de moindre résistance au courant électrique pour réduire le risque de court-circuit.

Cet orgue est équipé d'un câble ayant un fil de terre et une prise de terre. La prise doit être branchée dans une prise adéquate correctement installée et équipée de la terre conformément à toutes les normes en vigueur.

DANGER :

Une connexion impropre du fil de terre peut provoquer un court-circuit. Si vous avez un doute, vérifiez avec un électricien qualifié que le produit est correctement relié à la terre.

Ne modifiez pas la prise fournie avec le produit. Si elle ne se connecte pas avec la prise d'alimentation murale, faites installer une prise murale correcte par un électricien qualifié.

RESPECTEZ CES INSTRUCTIONS

Wichtige Sicherheitsvorschriften

Diese Sicherheitsvorschriften sollen die Feuer-, Kurzschluß- und Verletzungsrisiken herabsetzen.

Warnung: Während des Gebrauchs von elektrischen Geräten sollten Sie grundsätzlich immer Vorsichtsmaßnahmen beachten, einschließlich der folgenden:

1. Lesen Sie immer alle Beschreibungen und Warnungshinweise.
2. Dieses Gerät wurde mit einem eindeutigen Netzstecker versehen (Ein Kontakt ist größer als der andere). Dies ist eine Sicherheitsmaßnahme. Wenn der Stecker nicht in die Steckdose paßt, beauftragen Sie einen Elektriker mit der Änderung der Steckdose. Beseitigen Sie keinesfalls die Sicherheitsfunktion des Steckers.
3. Überlasten Sie nicht Wandsteckdosen und Kabel. Dies erhöht die Brand- und Kurzschlußgefahr.
4. Lassen Sie keine Gegenstände auf den Leitungen liegen.
5. Verhindern Sie, daß Gegenstände in die geöffnete Anlage fallen oder Nässe eindringt.
6. Trennen Sie die Orgel von der Steckdose und beauftragen Sie Fachpersonal in folgenden Fällen:
 - das Netzkabel ist gerissen oder beschädigt
 - Feuchtigkeit ist in das Gerät eingedrungen
 - Das Gerät wurde dem Wasser ausgesetzt
 - Das Gerät arbeitet nicht normal oder zeigt Fehler im Betriebszustand
 - Das Gerät ist gefallen oder das Gehäuse wurde beschädigt
7. Dieses Gerät, ob alleine oder in Verbindung mit externen Verstärker und Lautsprecher oder Kopfhörer benutzt, ist imstande, extreme Lautstärken zu erzeugen, was bei langzeitigem Gebrauch Hörschäden hervorrufen kann.
8. Versuchen Sie nicht das Gerät zu reparieren oder abzuändern, beachten Sie die Betriebsanleitung. Service und Reparaturen obliegen ausschließlich qualifiziertem Personal.

Grundsätzliche Instruktionen:

Dieses Gerät muß geerdet werden. Ist die Erdung nicht vorhanden oder unterbrochen, hat dies eine Minderung des elektrischen Schutzes vor Kurzschluß zur Folge. Dieses Gerät ist mit einem dreipoligen (Phase, Neutral und Erde) Stecker ausgestattet. Der Stecker muß an eine zugelassene, sorgfältig installierte und geerdete Steckdose angeschlossen werden, in Übereinstimmung mit den örtlichen gesetzlichen Bestimmungen.

Gefahr !! eine unvorschriftsmäßige Erdung und Anschluß erhöht die Gefahr eines elektrischen Schlag. Falls Sie Zweifel haben, ob Ihr elektrischer Anschluß richtig geerdet ist, lassen Sie ihn von einem Elektriker überprüfen. Nehmen Sie niemals Änderungen an dem Netzstecker des Gerätes vor - wenn er nicht paßt, beauftragen Sie einen qualifizierten Elektriker mit der Installation eines vorschriftsmäßigen Anschlusses.

Bewahren Sie diese Instruktionen sorgfältig auf

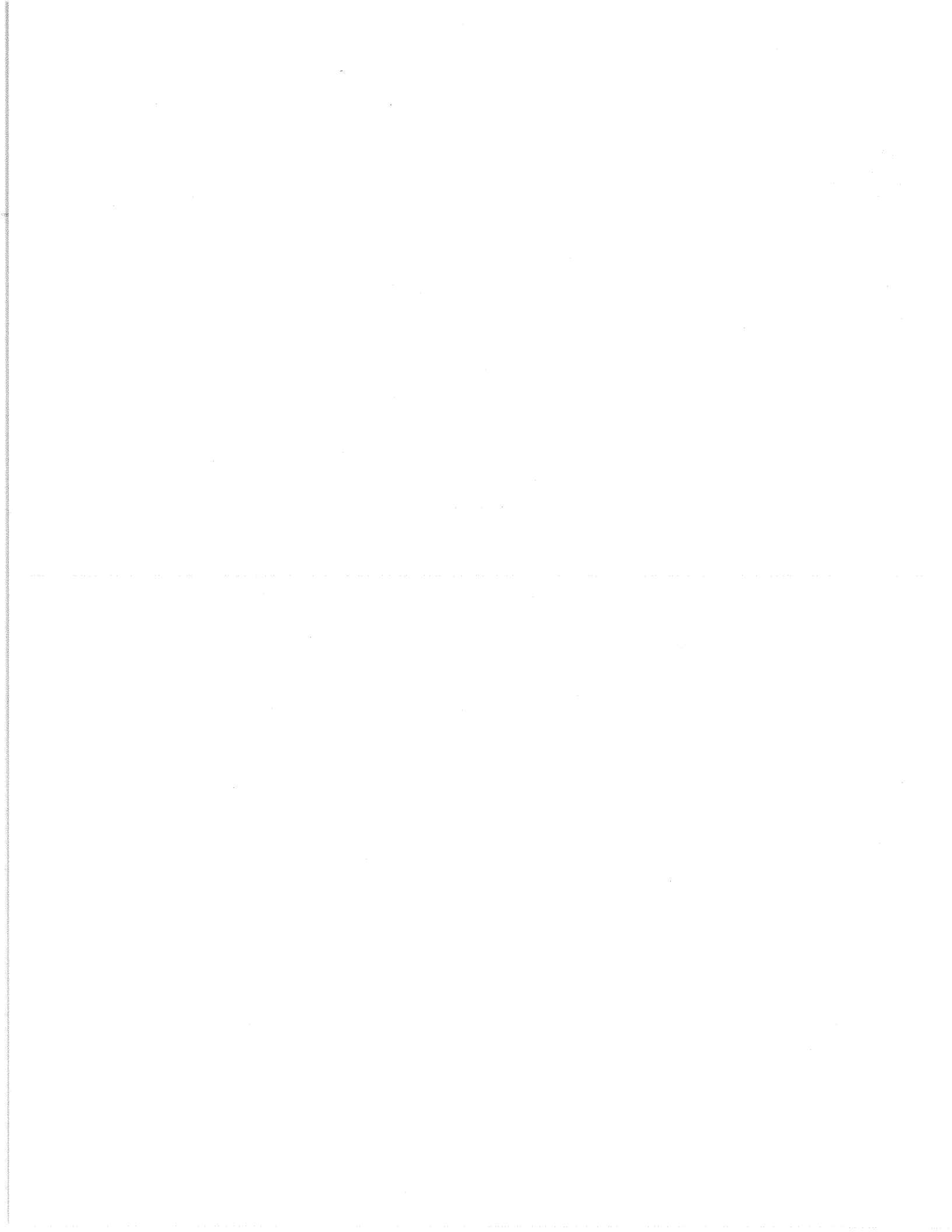

ALLEN ORGAN COMPANY

For approximately fifty years--practically the entire history of electronic organs--the Allen Organ Company has sought to build the finest organs that technology would allow.

In 1939, Allen built and marketed the world's first purely electronic oscillator organ. The tone generators for this first instrument used two hundred forty-four vacuum tubes, contained about five thousand components, and weighed nearly three hundred pounds. Even with all this equipment, the specification included relatively few stops.

By 1959, Allen had replaced vacuum tubes in the oscillator organs with transistors. Thousands of transistorized instruments were built, including some of the largest, most sophisticated oscillator organs.

Only a radical technological breakthrough could improve upon the fine performance of Allen's solid-state oscillator organs. Such a breakthrough came in conjunction with the U.S. Space Program in the form of highly advanced digital microcircuits.

Your MDS organ is the product of years of refinement in digital techniques by Allen engineers. It represents the apex of computer technology applied to exacting musical tasks. The result is an instrument of remarkably advanced tone quality and performance.

Congratulations on the purchase of your new Allen Digital Computer Organ! You have acquired the most advanced electronic organ ever built, one that harnesses a modern computer to create and control beautiful organ tones.

Familiarize yourself with the instrument by reading through this booklet. We call your attention particularly to sections on Transposer, Setting Pistons, and Double Preset System, since these elements are important to realizing the full potential of the instrument.

The sections on stop description and organ registration are intended for immediate use as well as for future reference. Because the Allen Digital Computer Organ offers limitless tonal possibilities, plus authentic tone quality, these subjects can now be more readily explored than ever before.

Contents

I. Description of Stops	1
II. Artistic Registration	9
III. Transposer	13
IV. Setting Pistons	14
V. MIDI Guide	15
VI. Double Preset System	19
VII. Installation, Voicing, and Care of the Organ	20



DESCRIPTION OF STOPS

PITCH FOOTAGE

The number appearing on each stop along with its name indicates the "pitch" or "register" of the particular stop. It is characteristic of the organ that notes of different pitches may be sounded from a single playing key. When this sound corresponds to the actual pitch of the playing key, the note (or stop) is referred to as being of 8' pitch; therefore, when an 8' stop is selected and middle C is depressed, the pitch heard will be middle C. If it sounds an octave higher, it is called 4' or octave pitch. If it sounds two octaves higher, it is called 2' pitch, while a stop sounding three octaves higher is at 1' pitch. Likewise, a 16' stop sounds an octave lower, and a 32' stop sound two octaves lower.

Stops of 32', 16', 8', 4', 2', and 1' pitch all have octave relationships, that is, these "even numbered" stops all sound octaves of whatever key is depressed. Pitches other than octaves are also used in organ work. Their footage number always contains a fraction, and they are referred to as mutations. Among these are the Nasard and Quinte $2\frac{2}{3}'$, Tierce $1\frac{3}{5}'$, and Quintflöte $1\frac{1}{3}'$. Because they introduce unusual pitch relationships with respect to the fundamental (8') tone, they are most effective when combined with other stops and used either in solo passages or in small ensembles of flutes (see explanation of Cornet in Section II).

TONAL FAMILIES

Organ tones divide into two main categories: flues and reeds. In a pipe organ, flue pipes are those in which the sound is set in motion by wind striking directly on the edge of the mouth of the pipe. Flues include principal tones, flute tones, and string tones. Compound stops and hybrid stops are "variations" within these three families.

The term "imitative" means that the organ stop imitates the sound of the corresponding orchestral instrument; for example, an imitative "Viola 8'" would be a stop voiced to sound like an orchestral viola.

Principal Voices

Principal
Diapason
Octave
Superoctave
Quinte

Characteristic organ tone, not imitative of orchestral instruments. Usually present at many pitch levels, as well as in all divisions. Rich, warm, and harmonically well developed.

Flute Voices

Open Types:

Harmonic Flute
Melodia
Flute mutation stops

Voices of lesser harmonic development than principals. Open types somewhat imitative; stopped types not. Present at all pitch levels and in all divisions.

Stopped Types:

Gedackt, Bourdon,
Quintadena
Rohrflöte

String Voices

Salicional
Viola
Voix Céleste

Mildly imitative voices of brighter harmonic development than principal. Usually appear at 8' pitch.

Compound Voices

Mixture
Cornet

Voices produced by more than one rank sounding simultaneously.

Hybrid Voices

Gemshorn
Erzähler
Spitzflöte

Voices that combine the tonal characteristic of two families of sound, e.g., flutes and principals, or strings and principals.

In *reed* pipes, a metal tongue vibrates against an opening in the side of a metal tube called a shallot. The characteristic sounds of different reeds are produced through resonators of different shapes. The family of reeds subdivides as follows:

Reed Voices

Chorus or
Ensemble Types:

Trumpet, Posaune,
Clairon

Voices of great harmonic development; some imitative,
others not.

Solo Types:

Hautbois, Clarinet,
Krummhorn

The Allen Digital Computer Organ provides authentic examples of various types of voices as listed above. Some of these are protected by copyrights owned by the Allen Organ Company. The voices are stored in memory devices, each having affixed to it a copyright notice; e.g., © 1990 AOCO, © 1991 AOCO, etc., pursuant to Title 17 of the United States Code, Section 101 et seq.

Following is a discussion of individual stops and how they are generally used. Please note that slight variations in specifications may be encountered.

MDS-1 STOPLIST

PEDAL ORGAN

Bourdon 16'	Stopped flute tone of weight and solidity.
Lieblichgedackt 16'	Softer stopped flute voice of delicacy and definition. Useful where soft 16' pitch is required.
Octave 8'	8' member of the Pedal principal chorus.
Gedackt 8'	Stopped flute tone of 8' pitch, useful in adding clarity to a pedal line in combination with the Bourdon 16' or Lieblichgedackt 16'.
Choralbass 4'	Pedal 4' principal tone.
Mixture II	Compound stop of principal tones. One pedal produces two distinct pitches at octave and fifth relationships to the pedal being pressed. Used to crown the Pedal principal chorus.
Basson 16'	Pedal reed that lends strength and "snarl" to the Pedal line.
Trompette 8'	Clear Pedal reed useful in adding definition to a full Pedal combination, or as a solo Pedal trumpet.
Great to Pedal	Connects all Great stops to the Pedal.
Swell to Pedal	Connects all Swell stops to the Pedal.
MIDI to Pedal	Opens MIDI channel to the Pedal.

SWELL ORGAN

Bourdon 16'	Softer stopped flute tone of weight and solidity.
-------------	---

Gedackt 8'	Stopped flute tone of moderate harmonic development. Provides the 8' member of the Swell flute chorus and is useful by itself or with other flutes and mutations in creating solo voices.
Viola 8'	Soft 8' string tone.
Viola Celeste 8'	Soft accompanimental string celeste.
Spitzprinzipal 4'	Hybrid stop which is predominantly principal tone with a stringlike edge.
Koppelflöte 4'	Distinctive stopped flute voice that works well in ensembles of flutes or strings, or as a solo voice.
Nasat 2-2/3'	Flute mutation that sounds one octave and a fifth above the keys played. Always used with other stops (usually beginning with 8') for coloration.
Blockflöte 2'	A delicate, clear open flute at 2' pitch.
Basson 16'	Chorus reed tone at the 16' pitch level, designed to supplement and undergird the other chorus reeds. Also usable as a distinctive solo reed.
Trompette 8'	Chorus reed stop of rich harmonic development. Can also be used as a solo voice.
Tremulant	Use of this stop provides a vibrato effect, natural in the human voice and wind instruments, when used with the stops in the Swell division.
MIDI to Swell	Opens MIDI channel to the Swell.

GREAT ORGAN

Principal 8'	Foundation stop of the Great principal chorus.
Gedackt 8'	Full-bodied, stopped flute tone.
Octave 4'	The 4' member of the Great principal chorus, which consists of the Principal 8', Octave 4', and Super Octave 2'.
Koppelflöte 4'	Distinctive stopped flute voice that works well in ensembles of flutes or strings, or as a solo voice.
Super Octave 2'	An open metal stop that produces foundation tone at the 2' pitch level.
Mixture IV	A compound stop of principal tones. Four notes in octave and fifth relationships sound together when a single key is depressed. As pitches progress upward, they "break" back to the next lower octave or fifth. Used to cap the Great principal chorus, adding brilliance and pitch definition throughout the entire compass.
Chimes	Typical Tubular Chimes.
Krummhorn 8' (optional in lieu of Chimes)	The tone quality of the shawm, a medieval ancestor of the Clarinet, is the basis for this light, bright, nasal reed. It can be used alone as a solo stop, or combined with light flues for a somewhat rounder reed solo effect.
Tremulant	Same as Tremulant in Swell, but affects stops in the Great and Pedal, except for the bottom octave in both divisions.
Swell to Great	Intermanual coupler connecting all Swell stops to the Great manual.
MIDI to Great	Opens MIDI channel to Great.

GENERALS

Memory B	When used, this tablet allows access to seven additional general pistons that are completely independent of those on the "A" memory.
Add Stops	Allows the addition of manually selected stops to a stop combination selected from a General piston.
Bass Coupler	When this coupler is used, the lowest note played on the Great manual will automatically key the appropriate Pedal note, playing those stops that have been drawn in the Pedal division as well as those in the Great division.
Melody Coupler	When used with an appropriate solo stop, such as a Swell reed, this feature will automatically key the highest note played on the Great, allowing accentuation of the melody.
Romantic Tuning Off	When activated, a second, "tight" tuning is drawn, resulting in a less warm sound.
Reverb	Stop engages reverberation system.
Vibrato (optional)	Similar to the Tremulant, but with much greater depth to the movement. Typical "gospel" sound.
Console Speakers Off (optional)	Used to switch off speakers inside the console.
External Speakers Off (optional)	Used to switch off external speakers. The organ will speak only from the console speakers.

EXPRESSION PEDALS

There is one expression pedal on the MDS-1. It expresses the Swell, Great and Pedal divisions.

CELESTES

Celestes are created by using two sounds, one tuned slightly sharp or flat of the other, creating a warm, undulating, "celestial" effect. The combination of the Viola 8' and Viola Celeste 8' in the Swell division will create a beautiful celeste sound.

ARTISTIC REGISTRATION

Organ registrations fall into two broad categories: solo combinations and ensembles.

A solo combination is one in which a melody is played on one keyboard, the accompaniment on another keyboard, and the pedal often provides a light bass line. Almost any stop or combination of stops will sound good as a solo voice. A contrasting tone quality should be chosen for the accompaniment, so that the accompaniment is softer than the solo voice. The Pedal needs to provide a foundation for the sound without covering it.

Most 8' reed stops make interesting solo voices. The addition of a 4' flute or a flute mutation (e.g., Nasard or Tierce) to a light reed such as the Hautbois colors the sound further and increases its volume slightly. Adding an 8' flute to a reed will add body to the sound.

Flutes can be used alone or in combinations as solo voices.

When choosing stops for a solo voice, it is not always necessary to include an 8' stop; for example, since the 4' flute has a tone quality different from that of the 8' flute, the 4' flute can be used as an independent solo voice. By playing the solo an octave lower than written, the notes will sound at the correct pitch. In similar fashion, a 16' stop can be selected and the notes played an octave higher than written. Tonal variety will be gained, because each stop has its own tone color.

For accompaniment, the most desirable voices are the 8' flutes and strings on each manual. Celestes often make effective accompaniments. The correct choice depends on the volume of the solo tone (a soft solo voice requires the softest accompanimental stop), the element of contrast, and the location of the solo stop. A bright, harmonically rich solo reed, for example, can be accompanied by either a string or flute, but the flute will often contribute greater interest because of its greater contrast.

Try to seek a "natural" balance of volume between solo and accompaniment. This will be especially helpful if the solo and accompaniment are under separate expression.

SUGGESTED SOLO REGISTRATIONS

CHIMES SOLO

Swell: Gedackt 8', Viola 8' Viola Celeste 8'
Great: Chimes
Pedal: Lieblichgedackt 16', Swell to Pedal

Play solo on Great.

SWELL SOLO COMBINATION

Swell: Gedackt 8', Koppelflöte 4', Nasat 2-2/3', Blockflöte 2' (Tremulant optional)
Great: Gedackt 8'
Pedal: Lieblichgedackt 16', Gedackt 8'

Play solo on Swell.

FLUTE SOLO

Swell: Viola 8', Viola Celeste 8'
Great: Gedackt 8' (Tremulant optional), or Koppelflöte 4'
Pedal: Lieblichgedackt 16'

Play solo on Great.

TRUMPET SOLO

Swell: Trompette 8'
Great: Principal 8', Octave 4', Super Octave 2'
Pedal: Bourdon 16', Octave 8', Choralbass 4'

Play solo on Swell.

These few combinations demonstrate basic techniques of solo registration. In creating registrations of your own, remember these three simple rules:

1. Seek tonal contrast between solo and accompaniment.
2. Be sure the solo is louder than the accompaniment.
3. Choose a solo whose character is appropriate to the specific piece.

ENSEMBLE REGISTRATIONS

Ensemble registrations involve groups of stops that are played together, usually, but not always, with both hands on one keyboard. They are characterized by compatibility of tone, clarity, and occasionally power. Such registrations are used in hymn singing, choir accompaniments, and much of the contrapuntal organ literature.

Volumes have been written on the subject of ensemble registration. Following is a summary of the major points.

Ensembles are created by combining stops. Two factors are always to be considered: tone quality and pitch. Ensembles begin with a few stops at the 8' and/or 4' pitch and expand "outward" in pitch as they build up. New pitches are usually added in preference to another 8' stop.

Ensembles are generally divided into three tonal groupings or "choruses":

The principal chorus is the most fully developed with representation in various divisions of the organ and at every pitch from 16' (Diapason) to high mixtures. The principal chorus is sometimes called the narrow-scale flue chorus, a pipe reference to the relative thinness of principal pipes in relation to their length.

The flute chorus is also well represented with a diversity of stops at various pitches. Generally speaking, the flute chorus is composed of less harmonically developed tones, and is smoother and of lesser volume than the principal chorus. The flute chorus is sometimes called the wide-scale flue chorus, owing to the generally "fatter" look of flute pipes as compared to principals.

The reed chorus includes those reed tones designed to be used in the ensemble buildup. Not all reed voices are ensemble tones. An Hautbois, for example, is usually a solo stop. The various Trumpets, Clairons, Bassons, etc., are usually ensemble voices that add brilliance, power, and incisiveness to the sound. If you have questions as to whether a specific reed is a solo or ensemble stop, refer to the stop glossary in the preceding section.

The Swell reed chorus of Basson 16', Trompette 8', and Clairon 4' represents an entity important to French organ music and the full ensemble of the organ. These stops create a "blaze" of richly harmonic sounds that tops off both flue choruses.

Here are typical ensemble combinations for the Swell and Great manuals:

Great

1. Gedackt 8', Koppelflöte 4'
2. Gedackt 8', Koppelflöte 4', Super Octave 2'
3. Principal 8', Octave 4'
4. Principal 8', Octave 4', Super Octave 2'
5. Principal 8', Octave 4', Super Octave 2', Mixture IV
6. Principal 8', Gedackt 8', Octave 4', Koppelflöte 4', Super Octave 2', Mixture IV

Swell

1. Gedackt 8', Viola 8', Viola Celeste 8'
2. Gedackt 8', Koppelflöte 4'
3. Gedackt 8', Koppelflöte 4', Blockflöte 2'
4. Gedackt 8', Spitzprinzipal 4', Koppelflöte 4', Blockflöte 2'
5. Gedackt 8', Spitzprinzipal 4', Koppelflöte 4', Blockflöte 2', Nasat 2-2/3'
6. Gedackt 8', Spitzprinzipal 4', Koppelflöte 4', Blockflöte 2', Nasat 2-2/3', Trompette 8'

The use of the Swell to Great coupler allows these separate ensembles to be combined on the Great manual. It is also possible to combine some of these ensembles within the same division; for example, the #2 and #4 registrations suggested above for use on the Great combine to form a nice round hymn combination.

The Pedal ensemble is created in much the same way as the manual ensembles, starting at 16' pitch instead of 8'. Be careful that the volume of the pedals is not greater than that of the manuals. Although the manual to pedal couplers are useful in bringing clarity to the pedal line, especially on softer registrations, avoid the temptation to rely constantly on one or two 16' stops and a coupler. Please note that the softest stops and flute mutations are normally not used with ensembles.

FULL ORGAN

Due to the immense capabilities of the Allen Digital Computer Organ, every stop and coupler on the instrument could be used simultaneously without distortion, if the organ is adjusted properly. In good registration practice, however, the organist would not haphazardly put on every stop on the instrument. For best results, listen and include only those stops that really contribute to the fullness and brilliance of the ensemble. Eliminate soft stops and solo stops that make no purposeful contribution.

This short treatment barely scratches the surface of the fascinating subject of organ registration. For those interested in gaining further insight into this vital area of organ playing, we recommend the following texts:

- Audsley, George Ashdown. *Organ Stops and their Artistic Registration*.
Hialeah, FL: C.P.P. Belwin, 1985.
- Irwin, Stevens. *Dictionary of Pipe Organ Stops*. 2nd ed.
New York: Macmillan Books, 1983.

TRANSPOSER

The vast capability of the computer makes it possible to perform the sometimes difficult task of transposing while allowing the organist to play in the notated key.

Operation of the Transposer is controlled by the Transposer knob. Neutral (no transposition) position for this knob is marked "N."

To shift the music to a higher key, move the knob upward one or more half-steps. The key can be raised a maximum of five half-steps, in half-step increments.

To shift to a lower key, move the Transposer knob downward from "N." The key can be lowered a total of seven half-steps.

A RED LIGHT COMES ON WHENEVER THE TRANSPOSER KNOB IS MOVED FROM THE "N" POSITION.

WHY TRANSPOSE?

1. Because the range of a given song will not always suit the vocal range of a particular singer. By adjusting the key upward or downward, whichever is appropriate, the piece can be sung more comfortably and effectively.
2. Because some instruments are non-concert pitch. A trumpet in B^b, for example, can read the same music as the organist, if the Transposer knob is set two half-steps lower.
3. Because hymn singing can sometimes be improved by a more favorable key selection. Hymn singing can also be enhanced by playing the hymn in its original key, playing a short modulation at the end of the stanza that leads into the key one-half step above the key in which the hymn is written, then turning the Transposer up a half-step for the next stanza. In this way, the organist can play the next stanza in its original key, and it will sound one-half step higher. If the hymn is already in a fairly high key, it may be preferable to play the first few stanzas with the Transposer set *down* one-half or one whole step, then modulate up to the original key for the final stanza. The use of modulation with the aid of the Transposer can create a climactic effect for the final stanza of a hymn.

SETTING PISTONS

Allen's double memory system allows the organist to set two complete groups of piston combinations covering the entire organ, or each of two organists to set his or her own combinations on one memory. Select the capture memory you want to use by depressing the Memory B stop tablet for Memory B, or leaving it in the up position for Memory A.

Choose a stop combination that you wish to place on General Piston 1, for example. General pistons are found in the center of the console underneath the Swell manual and are numbered 1 through 7. Remember that generals are customarily set from soft to loud using graduated stop combinations. After you have selected your stops, press and hold the "Set" button and the press and release General Piston 1. Release the "Set" button. General Piston 1 will now bring on that combination, until someone changes it. NOTE: Because the MDS-1 does not have a moving capture system, no stop tablets will move when a general piston is pressed. The stop combination on that piston will play, however. The red LED indicator light to the right of the Great manual will read from 1-7 depending on the general piston selected.

MIDI GUIDE

MIDI FOR ORGANISTS

- A. What is MIDI?
- B. Type of MIDI Devices
- C. Types of MIDI Data
- D. MIDI as a Practice Tool
- E. MIDI as a Registration Tool
- F. Other Uses for MIDI
- G. Connecting the Allen Organ to other MIDI Devices
- H. MIDI capabilities of the MDS-1

MIDI FOR ORGANISTS

A. WHAT IS MIDI?

The term MIDI is an acronym for Musical Instrument Digital Interface. MIDI has been adopted by the music industry as a standard means of communication between digital musical devices. This enables devices of different types and manufacturers to communicate with ease. It is not necessary to understand all of the technical aspects of MIDI in order to take advantage of the benefits it offers. Most of today's MIDI devices are easy to operate. It is important to explore the potential MIDI holds for musicians, as well as the various MIDI applications available today.

B. TYPES OF MIDI DEVICES

MIDI devices fall into two categories. The first category consists of musical instruments such as organs and synthesizers, which transmit and receive MIDI data. The second category includes controllers and processors, that, as their name implies, can transmit, receive, or manipulate MIDI data but do not necessarily produce sound themselves. Sequencers, which are MIDI recording devices, fall into this category. Although the technical nature of their recording and editing processes differs from those of a tape recorder, many operate in similar fashion. Most are equipped with record, playback, fast forward and reverse controls, that function in the same way as their tape recorder counterparts.

C. TYPES OF MIDI DATA

There are several types of MIDI messages that can be sent from one device to another. The most common is keying information, allowing one device to sense which keys have been played on another. This means that an organ equipped with MIDI can send information to other MIDI devices, e.g., synthesizers or sequencers, and can play those devices simultaneously or record information to be played back later.

Most Allen Organ models incorporate a total MIDI system, allowing the transmission of volume information, registrations, Crescendo settings and more. It is even possible to control several devices from one manual simultaneously, or control different devices from each manual of the console.

D. MIDI AS A PRACTICE TOOL

For the organist/choir director, the MIDI organ console and sequencer are valuable rehearsal tools for both choral and organ works. Anthem accompaniments may be recorded in advance and played back by the sequencer during choir rehearsal, freeing the director from the role of accompanist, and allowing him to concentrate on directing the choir. The sequencer may even play the music back at a slower tempo without affecting pitch, or at a lower pitch without affecting tempo, features that are useful in rehearsing difficult choral passages. If the sequencer allows multi-tracking (most sequencers do), each vocal section's part may be recorded on a different track, and then played back individually, or in any combination, for increased flexibility.

Multi-tracking can also be used in teaching and learning new organ works. The teacher may record each hand or pedal part on a different track, allowing the student to "mute" or turn off any part being practiced while still being able to hear the sequencer play the rest of the composition. The student's ability to hear the piece in its entirety and to become aware of, from the earliest stage of learning a composition, the interrelationship of its voices, is especially valuable in learning contrapuntal works.

E. MIDI AS A REGISTRATION TOOL

In some churches and auditoriums it is difficult to judge the effectiveness of a registration from the organ console. Due to the acoustics of the room, or positioning of the console, the sound of the instrument may be different when listened to from the congregation's or audience's vantage point. MIDI allows the organist to check registrations by recording his playing and registration to a sequencer and then listening from different locations in the room during the music's playback.

F. OTHER USES FOR MIDI

MIDI has opened new possibilities to the organist. The MIDI organ console's ability to control external keyboards or sound modules puts an ever increasing array of non-traditional sounds at the organist's fingertips, with a degree of control only possible through the flexibility of an organ console. The ability to record MIDI data with the use of a sequencer opens a variety of new possibilities, both in practice and performance situations. Computer programs are even available that allow musicians to play MIDI devices connected to a computer and have their performance printed out as conventional five line musical notation. Because MIDI is an industry-wide standard, today's MIDI instruments will be compatible with tomorrow's MIDI innovations.

G. CONNECTING THE ALLEN ORGAN TO OTHER MIDI DEVICES

MIDI-capable Allen Organ consoles may be connected to a variety of MIDI devices. The last page of this manual contains diagrams illustrating the proper procedures for connecting the Allen Organ to an assortment of MIDI devices. Although the diagrams are not meant to be an exhaustive list of possibilities, they illustrate the most commonly used combinations of MIDI devices. If more specific information is required, please consult the owner's manuals of the external devices being connected to the Allen Organ.

H. MIDI CAPABILITIES OF THE MDS-1

The MDS-1 features Allen's TOTAL MIDI system. TOTAL MIDI offers complete record/playback capability via MIDI sequencer, and enables console pistons to control presets of external keyboards or sound modules. TOTAL MIDI gives the organist the ability to record and play back entire scores, including keying, registration, and expression.

The MIDI ports on the MDS-1 are located under the left key cheek. The MIDI IN port allows the Allen Organ to receive MIDI data from external MIDI devices. Conversely, The MIDI OUT port allows the Allen Organ to transmit MIDI data to external MIDI devices. The MIDI THRU port allows the same MIDI data received via the MIDI IN port to be passed to other MIDI devices.

The General pistons on the MDS-1 will send a patch change number equal to the piston number; i.e., General piston 1 will send patch change number 1, etc.

The MDS-1 transmits and receives MIDI data for the Swell division on MIDI Channel 1. MIDI data for the Great division is transmitted on MIDI Channel 2, and the Pedal division uses MIDI Channel 3.

TOTAL MIDI greatly expands the capabilities of the MDS-1, and a variety of MIDI devices can be used with the MDS-1. It is important, therefore, to consult the owner's manual specific to any device you wish to use for proper hook-up instructions.

DOUBLE PRESET SYSTEM

The MDS-1 organ is equipped with Allen's Double Memory Preset System, which offers the ultimate in registration control and convenience. Double memories provide a total of 14 separate combinations.

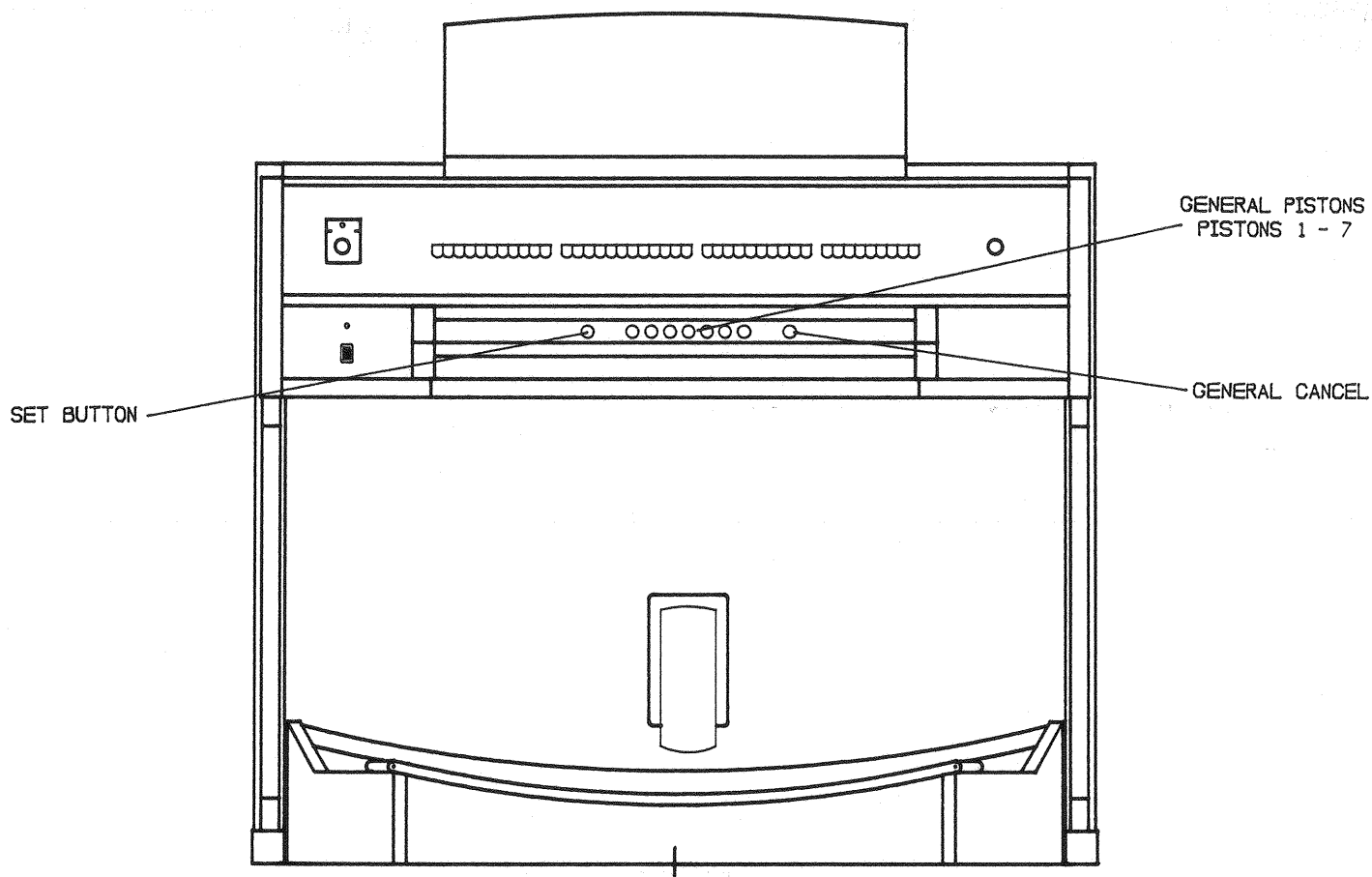

THINGS TO REMEMBER

General pistons affect all stops. Interdivisional couplers (Swell to Great, Swell to Pedal, Great to Pedal) operate from the general pistons.

All pistons operate independently from each other.

The preset system is not fully operable until approximately six seconds after the organ is turned on.

INSTALLATION, VOICING, AND CARE OF THE ORGAN

INSTALLATION

Wherever your MDS-1 organ may be situated, careful installation is a prerequisite to successful results. Your Allen representative is well qualified to guide you in planning for this.

Factory assistance in planning the installation is also available and may, in fact, be sought by your representative, in order that optimal results may be achieved.

VOICING

The MDS-1 organ enjoys unprecedented accuracy in the scaling and voicing of each note of every stop. This musical breakthrough is an inherent part of the engineering design of the instrument. Final adjustments in scaling and voicing involve controls within the console and are best left to an expert. These adjustments are normally a part of installation and, once done, should not require changes, unless the instrument is moved to a new location.

Bass frequency projection is strongly affected by tone cabinet location. Although none of the tone cabinets should be moved once the installation has been completed, extra care should be exercised to prevent inadvertent movement of the bass tone cabinets.

REVERBERATION

The optional ADR-4 Digital Reverberation System provides the spatial ambience of a large reverberant auditorium. Although most effective in poor acoustic environments, it even enhances the tones in an ideal acoustic setting.

Adjustment of reverberation can be accomplished by your service technician or sales representative.

CARE OF THE ORGAN

Your Allen Digital Computer Organ constitutes a major advance in long-term maintenance-free operation. There are no regular maintenance procedures required and, therefore, no periodic maintenance schedules to be observed.

Reasonable care will keep the instrument looking beautiful for years to come. If desired, polish the wooden portions with a high-grade furniture wax. *Do not* use abrasive polishes, cleaners, or waxes containing silicone.

Keys and stop tablets should be cleaned in the following manner: Use two clean cloths. Immerse one in clear, lukewarm water and wring it thoroughly damp dry. Loosen the dirt with this cloth, then polish immediately with the dry cloth. Do not use soap or detergent on keys or stop tablets.

You have purchased a remarkable organ that not only faithfully reproduces the organ traditions of the past but also anticipates the innovations of the future. Should you have questions that are not addressed in this manual, please do not hesitate to contact your local Allen Organ representative. Welcome to the family of satisfied Allen Organ owners!

USA ONLY

CAUTION

Do not plug the instrument into any current source other than 105-128 volts, 50/60 Hertz alternating current (AC). A verified grounded outlet is essential to proper operation and protection of the instrument. Proper polarity should be checked with an AC circuit analyzer before connecting the organ.

Do not change the cable plug or remove the ground pin or connect with a two-pole adapter.

If you are in doubt about your electrical connection, consult your local electrician or power company.

In churches where circuit breakers are turned off between worship services, the circuit breaker affecting the organ console AC power should have a guard installed to prevent its being accidentally switched off.

Read and comply with all instructions and labels that may be attached to the instrument.

Warning: This equipment generates, uses, and can radiate radio frequency energy and, if not installed and used in accordance with the instruction manual, may cause interference to radio communications. It has been type tested and found to comply with the limits for a Class B Computing Device in accordance with the specifications in Subpart J of Part 15 of FCC Rules, which are designed to provide reasonable protection against such interference in a residential installation. Should this equipment cause interference to radio communications, the user at his own expense will be required to take whatever measures may be necessary to correct the interference. Whether this equipment actually causes the interference to radio communications can be determined by turning the equipment off and on. The user is encouraged to attempt to correct the interference by one or more of the following measures:

Reorient the receiving antenna.

Relocate the organ with respect to the receiver.

Move the organ away from the receiver.

Plug the organ into a different electrical outlet, so that the organ and receiver are on different branch circuits.

If necessary, the user should consult the dealer or an experienced radio technician for additional suggestions.

CE mark shows compliance with the EMC Directive.

INTERNATIONAL ONLY

CAUTION

Do not plug the instrument into any current source other than that stated by the selling dealer. Proper polarity should be checked with an AC circuit analyzer before connecting the organ.

Do not change the cable plug or remove the ground pin (if applicable).

If you are in doubt about your electrical connection, consult your local electrician or power company.

In churches where circuit breakers are turned off between worship services, the circuit breaker affecting the organ console AC power should have a guard installed to prevent its being accidentally switched off.

Read and comply with all instructions and labels that may be attached to the instrument.

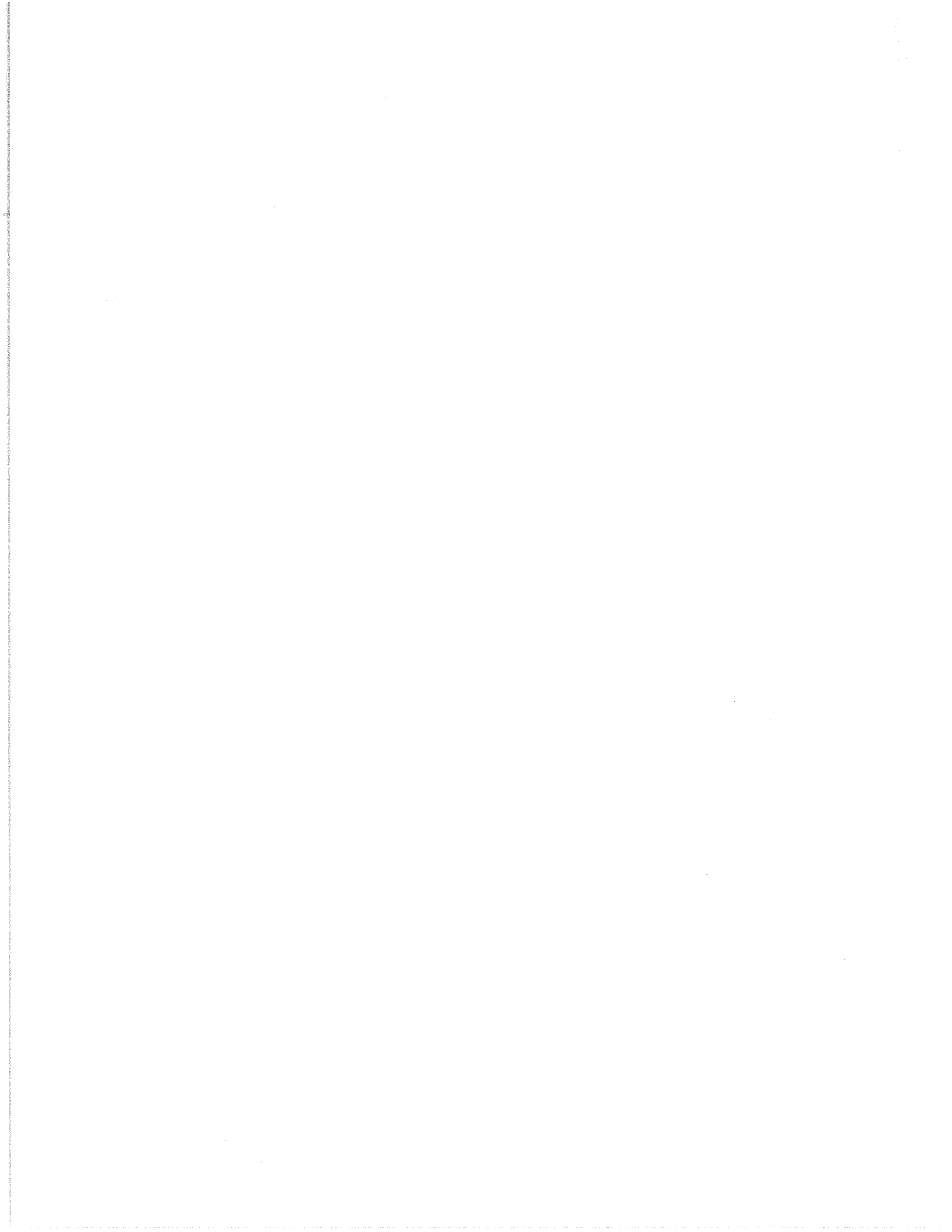

MIDI HOOKUP PROCEDURE - ORGAN, MDS-EXPANDER™, AND SMART RECORDER™

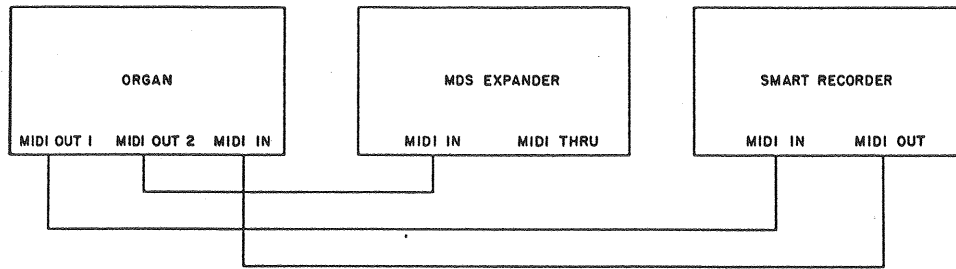

MIDI HOOKUP PROCEDURE - ORGAN, SMART RECORDER™, AND TWO MDS-EXPANDERS

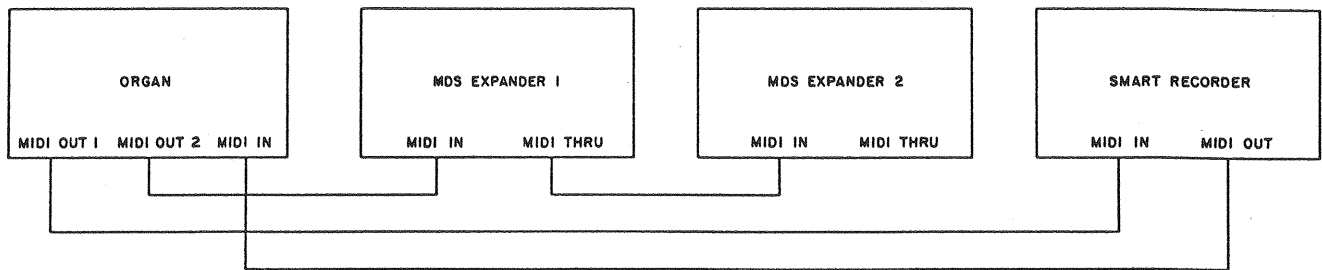

HOOK-UP PROCEDURE FOR RECORDING AND PLAYBACK USING EXTERNAL SEQUENCER AND MIDI SOUND MODULE ON MDS ORGANS WITHOUT SMART MIDI

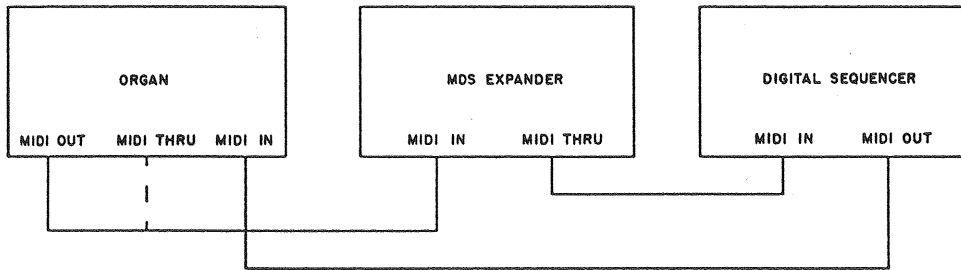

NOTE: MOVE MIDI CABLE FROM ORGAN MIDI "OUT" TO ORGAN MIDI "THRU" FOR PROPER PLAYBACK.

ALLEN ORGAN CO. Macungie Pennsylvania		
BLOCK DIAGRAM FOR MDS EXPANDER AND SEQUENCER		
by LQ	scale	material
chk'd.	date 8/23/94	NO.
	app'd.	020-0176

ADDENDUM

BATTERY BACKUP SYSTEM

The memory for the capture system on your MDS organ is sustained by a Lithium battery. This allows capture settings and related items to be retained in memory when the organ is switched off or unplugged. Under normal circumstances, the Lithium battery should last for several years. A built-in warning system will alert you when the battery becomes weak and needs to be replaced.

On Allen MDS organs that include a Console Controller™, the LCD display will flash a warning message for a few seconds during power-up when the battery requires replacement. The display will read as follows:

WARNING!!
Replace Battery

On Allen MDS organs without a Console Controller™, the green power light will flash for about ten seconds after the organ is switched on.

Should the battery in your MDS organ require replacement, contact your local Allen authorized service representative.